



دائرة اللوازم والمشتريات

عطاء رقم (T18 /2020.21)

أجهزة ولوازم العلاج الطبيعي والعلاج الوظيفي

2020-2021



عطاء أجهزة ولوازم العلاج الطبيعي والعلاج الوظيفي

وثائق العطاء:

أ- الجزء الأول:

(1) دعوة العطاء

(2) الشروط والتعليمات التنظيمية للعطاء

(3) طريقة الدفع

ب- الجزء الثاني:

(1) جدول الكميات والمواصفات الفنية

جدول أسعار رقم (1) العلاج الوظيفي

جدول أسعار رقم (2) العلاج الطبيعي



الجزء الأول (1)

إعلان طرح عطاء رقم T18/2020.201

أجهزة ولوازم العلاج الطبيعي والعلاج الوظيفي

تدعو الجامعة العربية الأمريكية الشركات المختصة الى المشاركة في العطاء المذكور أعلاه. يمكن الاستفسار أو الحصول على وثائق العطاء من دائرة اللوازم والمشتريات في الجامعة/ مبنى الدوائر الإدارية الطابق الثاني، هاتف- 04 2418888- تحويلة 1488 فاكس 04 2510972 بريد الكتروني pnp@aaup.edu مقابل مبلغ غير مسترد مقداره 100 دولار أمريكي تدفع في إحدى البنوك المعتمدة وذلك اعتباراً من يوم (الاحد) الموافق 2021/7/4.

ملاحظات :

1. تقديم عرضين: فني ومالي، وسيتم دراسة العروض فنياً ومالياً لاختيار العرض المناسب.
2. آخر موعد لتسليم العطاءات هو في تمام الساعة الثانية من يوم (الاحد) 2021/7/25 ولنفس المكان.
3. يجب تقديم كفالة دخول عطاء 5% من قيمة العطاء على شكل كفالة بنكية أو شيك بنكي مصدق لصالح الجامعة العربية الأمريكية.
4. الأسعار (شيكل) وتشمل جميع الضرائب بما فيها ضريبة القيمة المضافة وعلى المورد تقديم الفواتير الضريبية وشهادة خصم المصدر.
5. الجامعة غير ملزمة بأقل الأسعار وبدون إبداء الأسباب.
6. رسوم الاعلان على من يرسو عليه العطاء.
7. بإمكانكم الاطلاع على النظام الداخلي لدائرة اللوازم والمشتريات من خلال زيارة صفحة الجامعة العربية الامريكية على الانترنت. www.aaup.edu



الشروط والتعليمات التنظيمية للطاء

(2)

1. على جميع المشاركين في العطاء الالتزام التام بهذه الشروط والتعليمات، وهي تعتبر جزءاً لا يتجزأ من أي أمر شراء أو عقد يبرم مع المشارك الفائزة ما لم ينص صراحة على خلاف ذلك في أمر الشراء أو العقد.
2. في هذه الشروط والتعليمات يرمز إلى "الجامعة العربية الأمريكية بالاختصار (AAUP)".
3. يجب أن تكون الشركة المتقدمة للطاء مسجلة رسمياً ومشتغلاً مرخصاً.
4. تقدم الأسعار (شيكال) شاملاً لجميع الضرائب بما في ذلك ضريبة القيمة المضافة (VAT).
5. يلتزم المشارك الفائزة بتقديم شهادات خصم المصدر والفواتير الضريبية اللازمة وأية مستندات قانونية أخرى تغطي عملية الشراء.
6. يجب أن تشمل الأسعار على جميع المصاريف المطلوبة من النقل والتركيب والتشغيل والفحص والصيانة والتدريب في المواقع المحددة في جدول المواصفات والكميات المرفق.
7. يجب أن تكون الأسعار المقدمة سارية المفعول لمدة لا تقل عن (90) يوماً من تاريخ تقديم العرض.
8. على المشارك الفائزة تقديم كفالة حسن تنفيذ خلال أسبوع من تاريخ الاتفاقية بحيث تعادل (10%) من قيمة الاتفاقية على شكل كفالة بنكية صادرة عن إحدى البنوك العاملة في فلسطين أو شيك مصدق صادر لصالح "الجامعة العربية الأمريكية".
9. إذا تخلف المناقص الفائزة عن تقديم كفالة حسن التنفيذ عن الموعد المحدد في البند السابق فإنه يحق لـ (AAUP) إلغاء الإحالة.
10. إذا تخلف المناقص الفائزة عن التوقيع على عقد التنفيذ و تسليم الكفالات والتأمينات المطلوبه منه خلال أسبوع من تاريخ قرار الاحالة، يعتبر مستنكفا عن تنفيذ العطاء ويصادر مبلغ الكفالة أو التأمين دخول العطاء بالاضافة الى ذلك يتحمل فرق السعر و/أو اي أضرار أخرى قد تلحق بالجامعة نتيجة استنكافه ويحرم من لمشاركة في عطاءات الجامعة لمدة عام.
11. إذا تخلف المناقص الفائزة عن تنفيذ العطاء الذي احيل عليه او خالف شرطاً من شروط العقد يحق للجامعة مصادرة كفالة دخول العطاء أو حسن التنفيذ أو جزء منها وتنفيذ العطاء مباشرة من الجامعة أو اية جهة تراها مناسبة بالاسعار والشروط والطريقة المناسبة ويتحمل المناقص أي فروقات بالاسعار مضاف اليها 15% من اجمالي قيمة العطاء.
12. يتحمل المناقص المتخلف دفع تعويض بدل اي عطل او ضرر قد يلحق بالجامعة نتيجة لذلك.
13. تعاد كفالة حسن التنفيذ بعد استكمال التوريد وجميع شروط العقد أو أوامر الشراء وبموجب الوثائق الاصولية اللازمة للاستلام.



14. على المشاركين في العطاء ارفاق كتالوجات عن المنتج.
15. يلتزم من يرسو عليه العطاء بدفع غرامة تأخير بواقع (0.1%) عن كل يوم تأخير من قيمة الأعمال المنجزة عن الوقت المحدد في الاتفاقية، ويتم احتساب هذه الغرامات من الدفعات المستحقة له أو من كفالة حسن التنفيذ.
16. يحق لـ (AAUP) إلغاء العطاء دون إبداء الأسباب كما أن (AAUP) غير ملزمة بإحالة العطاء على أقل العروض سعراً دون إبداء الأسباب. ولها أن ترفض كل أو بعض العروض المقدمة لها دون أن يكون لأي من المشاركين الحق في الرجوع إليها بأي خسارة أو ضرر ناجم عن تقديم عرضه ولا يترتب على (AAUP) أي التزامات مادية أو غير مادية مقابل ذلك، كما يحق لـ (AAUP) تجزئة العطاء بما تراه مناسباً ودون ابداء أسباب.
17. يلتزم من يرسو عليه العطاء بتقديم كفالة بنكية (صيانة) بقيمة (5%) من قيمة الأعمال المنجزة صالحة لمدة عام من تاريخ تسليم الأعمال.
18. على المشارك في العطاء تقديم عرضه على أساس المواصفات الفنية المبينة في وثائق العطاء وبموجب الكميات المحددة في جدول الكميات المرفق.
19. لا يجوز للمشارك في العطاء أن يتنازل لأي طرف آخر عن كل أو جزء من أمر الشراء دون الحصول على إذن خطي من (AAUP) مع الاحتفاظ بكامل حقوق (AAUP) وفقاً لشروط أمر الشراء.
20. عند دراسة العروض يؤخذ بعين الاعتبار كفاءة المناقص من الناحيتين المالية والفنية وقدرته على الوفاء بالتزامات العطاء وخبرته في تقديم اللوازم المطلوبة والسمعة التجارية والتسهيلات التي يقدمها ويجوز استبعاد عرضه لنقص كل أو بعض هذه المتطلبات.
21. لا تقبل العروض أو التعديلات التي ترد بعد التاريخ والموعده المحدد كآخر موعد لتقديم العروض.
22. يجب تعبئة جداول المواصفات المرفقة و لن ينظر بأي عرض لا يلتزم بتعبئة الجداول.

- ❖ ويسمح بتقديم عرضان اثنان فقط كحد أقصى لكل بند.
- ❖ يجب تقديم عرضي الاسعار الفني والمالي بنسختين: الأولى ورقية، والأخرى الكترونية (محوسبة).
- ❖ تقديم العرضين المالي والفني الورقيين بالظرف المختوم، مع ضرورة وضع ختم الشركة والتوقيع على كل الصفحات (للعرض المالي بالذات).



(3)

طريقة الدفع

خلال (90) يوماً من التوريد والقبول والاستلام النهائي، مقابل تقديم الكفالات المطلوبة.



الجزء الثاني1. جدول الكميات والمواصفات الفنية
عطاء لوازم العلاج الطبيعي والعلاج الوظيفيجدول أسعار رقم (1)
العلاج الوظيفي

| Item# | Product name | QTY | Unit | Unit Price ILS | Total Price ILS |
|-------|--------------------------------------------------------------|-------|------|----------------|-----------------|
| 1. | Parafin Bath, 3 kg, Chaatanoga, USA | 2.00 | عدد | | |
| 2. | Paraffin Wax | 20.00 | عدد | | |
| 3. | Hydrocollator (Cold Pack) | 4.00 | Each | | |
| 4. | Chilling unit for cryotherapy ENRAF, Model: C-5 | 1.00 | Each | | |
| 5. | Hot Pack USA | 10.00 | عدد | | |
| 6. | Hydrocollator® M-2 Mobile Heating Unit | 1.00 | عدد | | |
| 7. | Self Adhesive Velcor Hook | 8.00 | متر | | |
| 8. | Self Adhesive Velcor Loop | 8.00 | متر | | |
| 9. | Rectangular Gel Weighted Lap Pad | 2.00 | Each | | |
| 10. | Air splint set | 2.00 | Each | | |
| 11. | Stirling Elite Toilet Frame | 1.00 | Each | | |
| 12. | Guardian Padded Transfer Bench, folding | 1.00 | Each | | |
| 13. | Ultrasound unit ENRAF, Model: Enraf Sonopuls 190 | 1.00 | Each | | |
| 14. | Active Passive Trainer (APT) | 1.00 | عدد | | |
| 15. | Electrical Stimulation unit. Comprehensive unite ENRAF, Mode | 1.00 | Each | | |
| 16. | Scar TissueMassage Tool | 5.00 | Each | | |
| 17. | Norco MiniVibrator MultiHead MassagerNorco MiniVibrator Mult | 5.00 | Kit | | |
| 18. | Topigel SiliconeGel Sheeting | 2.00 | Each | | |
| 19. | Cica-Care SiliconeGel Sheet | 2.00 | Kit | | |
| 20. | Otoform Kc Scar Remodeling and Healing Elastomer | 2.00 | Kit | | |
| 21. | Mepiform SoftSilicone GelSheeting | 4.00 | Each | | |
| 22. | Putty-likeElastomer Kitsfor Sca | | Kit | | |
| 23. | Silipos Gel Sheetfor Scar | 5.00 | Each | | |
| 24. | BLACK FDI ERGODYNAMIC FOREARM CRUTCHES (EACH) | 5.00 | Each | | |
| 25. | GRAHAM-FIELD BARIATRIC CRUTCHES | 5.00 | Each | | |
| 26. | DRIVE HEAVY DUTY BARIATRIC WALKER | 5.00 | Each | | |
| 27. | MEDLINE EXTRA-WIDE TWO-BUTTON HEAVY DUTY WHEELED WALKER | 5.00 | Each | | |
| 28. | SCREW-TYPE MOBILE STOOL WITH NO BACK (SPECIFY UPHOLSTERY COL | 8.00 | Each | | |
| 29. | VELA TANGO 200 CHAIR (MANUAL TEENAGER & ADULT CHAIR) | 8.00 | Each | | |
| 30. | Kinesio Tex Taping | 10.00 | Kit | | |

| Item# | Product name | QTY | Unit | Unit Price ILS | Total Price ILS |
|-------|--------------------------------------------------------------|-------|------|----------------|-----------------|
| 31. | Sidhil Portable Bedhead Hoist | 1.00 | Each | | |
| 32. | Rope Ladder Bed Hoist Healthcare | 2.00 | Each | | |
| 33. | Peta Easi-Grip® Mounted Table Top Scissor (Plastic base) 45m | 4.00 | Each | | |
| 34. | PenAgain Ergosof Pen - Black | 5.00 | Each | | |
| 35. | C-Pen Exam Reader | 2.00 | Each | | |
| 36. | Driving simulator | 1.00 | Each | | |
| 37. | Bionness | 1.00 | Each | | |
| 38. | Fine motor and upper limb training station | 1.00 | Each | | |
| 39. | Upper extremity virtual/ smart training | 1.00 | Each | | |
| 40. | Smart exercise station | 1.00 | Each | | |
| 41. | Balance smart board | 1.00 | Each | | |
| 42. | Smart table | 1.00 | Each | | |
| 43. | Vertical Ring Tree | 2.00 | Each | | |
| 44. | Single Curved Shoulder Arc | 1.00 | Each | | |
| 45. | Semi – Circular Peg Board | 1.00 | Each | | |
| 46. | Cando twist bend bar | 2.00 | Kit | | |
| 47. | Incline Board | 1.00 | Each | | |
| 48. | Stacking Cones | 2.00 | Each | | |
| 49. | Easy Grip Pegs/Boards | 2.00 | Kit | | |
| 50. | Handmaster Plus | 4.00 | Each | | |
| 51. | Ergonomic Hand Exerciser | 2.00 | Each | | |
| 52. | Champion Sports Ring Toss Set | 1.00 | Each | | |
| 53. | Finger weight exerciser | 1.00 | Kit | | |
| 54. | Shoulder wheel | 1.00 | Each | | |
| 55. | Finger flexion/extension gauge | 1.00 | Each | | |
| 56. | finger extensor remedial game | 1.00 | Each | | |
| 57. | Digiflex exercise | 2.00 | Kit | | |
| 58. | Hand master plus | 5.00 | Each | | |
| 59. | Arm Support for Hand Elevation | 5.00 | Each | | |
| 60. | metal goniometer 6 piece set with case | 1.00 | Kit | | |
| 61. | Dynamic constant force X-tend | 1.00 | Each | | |
| 62. | Variable resistance exerciser for thumb and individual finge | 1.00 | Each | | |
| 63. | Fabri tape measure | 10.00 | Each | | |
| 64. | ultrasound gell | 3.00 | Each | | |
| 65. | therapeutic bean bag | 8.00 | Each | | |
| 66. | finger circumference gauge | 20.00 | Each | | |
| 67. | sensory stimulation activities | 1.00 | Kit | | |
| 68. | Power web hand exerciser A924-651 | 10.00 | عدد | | |
| 69. | Arm Skate | 1.00 | Each | | |
| 70. | Hand Strengthening Equipment | 10.00 | Each | | |
| 71. | Weights Set | 3.00 | Each | | |
| 72. | Dumbble | 5.00 | kg | | |

| Item# | Product name | QTY | Unit | Unit Price ILS | Total Price ILS |
|-------|--------------------------------------------------------------|-------|------|----------------|-----------------|
| 73. | Shoulder Wheel | 1.00 | عدد | | |
| 74. | Squeezing Bubble Tweezers | 2.00 | Each | | |
| 75. | Thera-Putty | 10.00 | علبة | | |
| 76. | Theraband exercise band 5.5m yellow/ thin | 2.00 | عدد | | |
| 77. | Theraband exercise band 5.5m red/medium. | 2.00 | عدد | | |
| 78. | Theraband exercise band 5.5m green/heavy. | 2.00 | عدد | | |
| 79. | Theraband exercise band 5.5m blue/ extra-heavy. | 2.00 | عدد | | |
| 80. | Theraband exercise band 5.5m black/special-heavy. | 2.00 | عدد | | |
| 81. | Theraband exercise band 5.5m silver/super-heavy. | 2.00 | عدد | | |
| 82. | Peanut ball | 2.00 | عدد | | |
| 83. | Physio ball 85cm | 2.00 | عدد | | |
| 84. | Green Therapy Ball, 16" ,20" ,24" Diameter | 2.00 | Each | | |
| 85. | Tactile Therapy Ball | 2.00 | Each | | |
| 86. | Allen Cognitive Level Screen (ACL-S) | 1.00 | Kit | | |
| 87. | Behavior Rating Inventory of Executive Function- Adult Versi | 1.00 | Kit | | |
| 88. | Lowenstein Occupational Therapy Cognitive Assessment (LOTCA) | 2.00 | Kit | | |
| 89. | Bayley Scales of Infant and Toddler Development-third editio | 1.00 | Kit | | |
| 90. | Beery VMI | 1.00 | Kit | | |
| 91. | Behavior Rating Inventory of Executive Function (BRIEF) | 1.00 | Kit | | |
| 92. | Bruininks OstereskyTest of Motor Proficiency- 2nd Ed- (BOT-2 | 1.00 | Kit | | |
| 93. | Miller Assessment for Preschoolers (MAP) | 1.00 | Kit | | |
| 94. | Peabody Developmental Motor Scales (PDMS) | 1.00 | Each | | |
| 95. | Pediatric Evaluation of Disability Inventory(PEDI) | 1.00 | Each | | |
| 96. | Quick Neurological Screening Test (QNST) | 1.00 | Kit | | |
| 97. | School Function Assessment (SFA) | 1.00 | Kit | | |
| 98. | Sensory Profile 2 | 1.00 | Each | | |
| 99. | Sensory Processing Measure (SPM) | 1.00 | Each | | |
| 100. | Observed Tasks of Daily Living (OTDL) | 1.00 | Each | | |
| 101. | Physical Work Performance Evaluation (PWPE) | 1.00 | Kit | | |
| 102. | hand function sort | 1.00 | Kit | | |
| 103. | Semmes Weinstein Monofilament Test | 2.00 | Each | | |
| 104. | Physical Work Performance Evaluation (PWPE) | 1.00 | Kit | | |
| 105. | Allen Cognitive Level Screen (ACL-S) | 1.00 | Kit | | |
| 106. | Behavior Rating Inventory of Executive Function- Adult Versi | 1.00 | Kit | | |
| 107. | hand function sort | 1.00 | Kit | | |
| 108. | Bayley Scales of Infant and Toddler Development-third editio | 1.00 | Kit | | |
| 109. | Behavior Rating Inventory of Executive Function (BRIEF) | 1.00 | Kit | | |
| 110. | Bruininks OstereskyTest of Motor Proficiency- 2nd Ed- (BOT-2 | 1.00 | Kit | | |
| 111. | Miller Assessment for Preschoolers (MAP) | 1.00 | Kit | | |
| 112. | Peabody Developmental Motor Scales (PDMS) | 1.00 | Each | | |
| 113. | Pediatric Evaluation of Disability Inventory(PEDI) | 1.00 | Each | | |
| 114. | Quick Neurological Screening Test (QNST) | 1.00 | Kit | | |



| Item# | Product name | QTY | Unit | Unit Price ILS | Total Price ILS |
|-------|--------------------------------------------------------------|-------|------|----------------|-----------------|
| 115. | School Function Assessment (SFA) | 1.00 | Kit | | |
| 116. | Sensory Profile 2 | 1.00 | Each | | |
| 117. | Sensory Processing Measure (SPM) | 1.00 | Each | | |
| 118. | Observed Tasks of Daily Living (OTDL) | 1.00 | Each | | |
| 119. | First STEP | 1.00 | Each | | |
| 120. | Grooved peg board | 1.00 | Each | | |
| 121. | thermoplastic Tape 3 cm Black | 20.00 | لفة | | |
| 122. | thermoplastic Tape 6 cm Black | 20.00 | لفة | | |
| 123. | More thermoplastic Tape 12 cm blue | 20.00 | لفة | | |
| 124. | More thermoplastic Tape 12 cm Black | 20.00 | لفة | | |
| 125. | Classic Soft (1.6 mm- 1/16") 45cm*60cm non perfo, sheet | 10.00 | Each | | |
| 126. | Classic Soft (1.6 mm- 1/16") 45cm*60cm micro perfo, sheet | 10.00 | Each | | |
| 127. | Classic Soft (2.0 mm- 1/12") 45cm*60cm non perfo, sheet | 20.00 | Each | | |
| 128. | Classic Soft (2.0 mm- 1/12") 45cm*60cm micro perfo, sheet | 10.00 | Each | | |
| 129. | Classic Soft (2.0 mm- 1/12") 45cm*60cm micro plus perfo, she | 10.00 | Each | | |
| 130. | Classic Soft (2.0 mm- 1/12") 45cm*60cm micro maxi perfo, she | 20.00 | Each | | |
| 131. | Classic Soft (2.0 mm- 1/12") 45cm*60cm micro mini perfo, she | 10.00 | Each | | |
| 132. | Classic Soft (2.5 mm- 3/32") 45cm*60cm micro perfo, sheet | 20.00 | Each | | |
| 133. | More thermoplastic Tape 12 cm blue | 20.00 | لفة | | |
| 134. | More thermoplastic Tape 12 cm Black | 20.00 | لفة | | |
| 135. | Classic Soft (3.2 mm- 1/8") 60cm*90cm non perfo, sheet | 2.00 | Each | | |
| 136. | Classic Soft (4.2 mm- 3/16") 60cm*90cm non perfo, sheet | 2.00 | Each | | |
| 137. | Classic STIFF (3.2 mm- 1/8") 60cm*90cm non perfo, sheet | 2.00 | Each | | |
| 138. | Classic STIFF (4.2 mm- 3/16") 60cm*90cm mini perfo, sheet | 2.00 | Each | | |
| 139. | small balls of thermoplastic material | 6.00 | علبة | | |
| 140. | Padding and Lining (Luxofoam non perforated) | 2.00 | لفة | | |
| 141. | Padding and Lining (Luxofoam perforated) | 2.00 | لفة | | |
| 142. | Padding and Lining (| 2.00 | لفة | | |
| 143. | Padding and Lining | 2.00 | لفة | | |
| 144. | Padding and Lining (Soft velvet edging strip (Black)) | 20.00 | رزمة | | |
| 145. | Hook and Loop Tape (Elastic Loop Tape) (25 mm - 1*25 m - 98 | 20.00 | لفة | | |
| 146. | Hook and Loop Tape (Splint STRAP)(25 mm- 1*400 mm - 15 3/4") | 2.00 | لفة | | |
| 147. | WORKING Tools (Ginger shears) | 20.00 | Each | | |
| 148. | Hospital Bed (Electrical) Haelvoet, Olympia Bed II- 4 Sectio | 2 | Each | | |
| 149. | VERTI ELECTRIC WALL FRAMES | 3 | Each | | |
| 150. | VERTI INSIDE ELECTRIC WALL FRAMES | 1 | Each | | |
| 151. | 4SINGLE TABLE FRAMES | 1 | Each | | |
| 152. | flexi worktop frames | 1 | Each | | |
| 153. | Biofeedback system | 1 | Each | | |
| 154. | Neuro feedback | 1 | Each | | |
| 155. | Electronic Jamar | 1 | Kit | | |
| 156. | adapted car | 1 | Each | | |

| Item# | Product name | QTY | Unit | Unit Price ILS | Total Price ILS |
|--------------|----------------------------------------------------------------------------------------|-----|-------|----------------|-----------------|
| 157. | hand held dynamometer | 1 | Each | | |
| 158. | coban tape | 50 | Piece | | |
| 159. | shape_texture identification test STI2 | 1 | Each | | |
| 160. | rehabilitation of the hand and upper extremity (7th edi) | 1 | Each | | |
| 161. | hand and upper extremity rehabilitation. A quick reference guide and review. (4th edi) | 1 | Each | | |
| 162. | hydrolec push_pull dynamometer | 1 | Each | | |
| 163. | suction pumb | 5 | Each | | |
| 164. | transfere and mobility device | 1 | Each | | |
| 165. | RoboTherapist 2D | 1 | Each | | |
| 166. | Clinic Pro Medical Software | 1 | Each | | |
| 167. | Fold N Half Mats | 2 | Each | | |
| 168. | Therapist Adjustable Therapy Chairs | 15 | Each | | |
| 169. | Adjustable Therapy Table | 6 | Each | | |
| 170. | Bobath bed | 2 | Each | | |
| 171. | standing frame for adults (adjustable) | 1 | Each | | |
| 172. | Electrical Tilting Table | 1 | Each | | |
| Total | | | | | |

- في حالة وجود استفسار يرجى تزويدنا بها من خلال البريد الالكتروني للرد عليها pnp@aaup.edu
- تقبل عروض الاسعار حسب الوصف اعلاه أو ما يعادله



مواصفات
العلاج الوظيفي

بند 2

Paraffin wax

Application: rehabilitation.

Origin: USA, EURO.

- Temperature control.
- On/off switch.
- Over temperature protection
- Cover.

| Paraffin wax | Yes/No | Comment |
|------------------------------------------------------------|---------------|---------|
| Manufacture | Manufacture | |
| Model | Model | |
| Origin | Origin | |
| Delivery time | Delivery time | |
| 3 years warranty and 10 years availability for spare parts | Yes/No | |
| Applications: rehabilitation. | Yes/No | |
| Temperature control. | Yes/No | |
| On/off switch. | Yes/No | |
| Over temperature protection | Yes/No | |
| Cover. | Yes/No | |
| Price include user and service manual | Yes/No | |
| Price include installation and training in site. | Yes/No | |



بند 6

Hydrocollator

Origin: USA, EURO.

- Volume: 50 L.
- Temperature range: 71– 75 C.
- Thermal Cut-Out Temp: 80 - 85 C.
- Heat up Time (to 71°C): 8 hours/day.
- fiberglass insulation to prevent heat loss.
- high grade stainless steel.
- Simple to fill with water (No plumbing required).
- With water drain for easy cleaning.
- Included in your unit price set of (3 HotPac and Foam Filled Terry).
- Optional price and cat No:

heater.

* يرجى التكرم بتعبئة الجدول بالأسفل بالإضافة الى تقديم عرض تقني خاص بالشركة

| Hydrocollator | Yes/No | Comment |
|------------------------------------------------------------------------|---------------|---------|
| Manufacture | Manufacture | |
| Model | Model | |
| Origin | Origin | |
| Delivery time | Delivery time | |
| Two years warranty and 10 years availability for spare parts | Yes/No | |
| Applications: rehabilitation. | Yes/No | |
| Volume: 50 L. | Yes/No | |
| Temperature range: 71– 75° C. | Yes/No | |
| Thermal Cut-Out Temp: 80- 85° C. | Yes/No | |
| Heat up Time (to 71°C): 8 hours/day. | Yes/No | |
| fiberglass insulation to prevent heat loss. | Yes/No | |
| high grade stainless steel. | Yes/No | |
| With water drain for easy cleaning. | Yes/No | |
| Your Price included with U.P: set of (3 HotPac and Foam Filled Terry). | Yes/No | |
| Simple to fill with water (No plumbing required) . | Yes/No | |
| Optional (Price & cat No): | | |
| Price include user and service manual | Yes/No | |
| Price include installation and training in site . | Yes/No | |

* يلتزم الشركة بتقديم كافة ملحقات والاضافات الازمة لعمل الجهاز تسعيرها بشكل واضح وابداء اية ملاحظات ضرورية للجهاز أو المكان قبل التوريد



بند 4

Chilling unit for cryotherapy

Application: rehabilitation.

Origin: USA, EURO.

- Volume: 50 L.
- Temperature range: - 10 to – 5 C.
- Type of Refrigerant: R-134A
- fiberglass insulation to prevent heat loss.
- high grade stainless steel.
- Simple to fill with water (No plumbing required).
- With water drain for easy cleaning.
- Your Price included with U.P: Set from (Blue Vinyl ColPac (Standard Size 28 cm x 36 cm, Neck contour 58 cm, 8 cmx 28 cm, Quarter Size 14 cm x 19 cm).

* يرجى التكرم بتعبئة الجدول بالأسفل بالإضافة الى تقديم عرض تقني خاص بالشركة

| Chilling unit for cryotherapy | Yes/No | Comment |
|-------------------------------------------------------------------------------------------------------------------------------------------------------|---------------|---------|
| Manufacture | Manufacture | |
| Model | Model | |
| Origin | Origin | |
| Delivery time | Delivery time | |
| Two years warranty and 10 years availability for spare parts | Yes/No | |
| Applications: rehabilitation. | Yes/No | |
| Volume: 50 L. | Yes/No | |
| Temperature range: - 10 to – 5 C . | Yes/No | |
| Type of Refrigerant : R-134A | Yes/No | |
| fiberglass insulation to prevent heat loss. | Yes/No | |
| high grade stainless steel. | Yes/No | |
| Simple to fill with water(No plumbing required) . | Yes/No | |
| With water drain for easy cleaning. | Yes/No | |
| Your Price included with U.P: Set from (Blue Vinyl ColPac (Standard Size 28 cm x 36 cm, Neck contour 58 cm, 8 cm x 28 cm, Quarter Size 14 cmx 19 cm). | Yes/No | |
| Price include user and service manual | Yes/No | |
| Price include installation and training in site . | Yes/No | |

* تلتزم الشركة بتقديم كافة ملحقات والاضافات اللازمة لعمل الجهاز تسعيرها بشكل واضح وابداء اية ملاحظات ضرورية للجهاز أو المكان قبل التوريد



بند 13

Ultrasound Therapy**Application: : rehabilitation.****Origin : USA ,EURO .****System include:****Ultrasound with all stander accessories to be ready to use****Display: wide and good resolution screen.****Pulse and continues therapy .Variable output : from 16 to 100 Hz.****Head warmer for probe . User friendly and simple.****Different clinical protocol.****1 & 3 MHz ultrasound frequencies pulse and continuous mode. Sound head coupling features with both visual & audio feedback. Head of ultrasound probe 5cm².****Option price: Cart . Probe : 5cm².****❖ Kindly your offer will not be taken into our consideration if you don't fill below table.**

| Ultrasound | Yes/No | Comment |
|-------------------------------------------------------------------------------------------|---------------|----------------|
| Manufacture | Manufacture | |
| Model | Model | |
| Origin | Origin | |
| Delivery time | Delivery time | |
| 3 years warranty and 10 years availability for spare parts | Yes/No | |
| Applications : | Yes/No | |
| The system include : rehabilitation. | Yes/No | |
| Ultrasound with all stander accessories to be ready to use | Yes/No | |
| Display: wide and good resolution screen. | Yes/No | |
| Pulse and continues therapy . | Yes/No | |
| Variable output : from 16 to 100 Hz. | Yes/No | |
| Different clinical protocol. | Yes/No | |
| 1 & 3 MHz ultrasound frequencies pulse and continuous mode. | Yes/No | |
| Sound head coupling features with both visual & audio feedback. | Yes/No | |
| Head of ultrasound probe 5cm². Included in u.p | Yes/No | |
| Option price: | | |
| Cart . | Price | |
| Probe : 5cm². | Price | |
| Price include user and service manual | Price | |
| Price include installation and training in site . | | |
| Any update of Software will be free of change if needed after of end the warranty. | | |



بند 15

Electrical stimulation Therapy

Application: : rehabilitation.

Origin : USA ,EURO .

System include:

Electrical stimulation with all stander accessories to be ready to use

2 channel (independent)

Display: wide and good resolution screen.

User friendly and simple.







With standard accessories and electrodes .

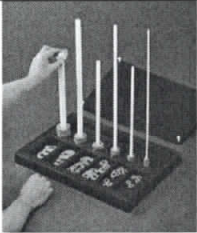

- *Kindly your offer will not be taken into our consideration if you don't fill below table.*

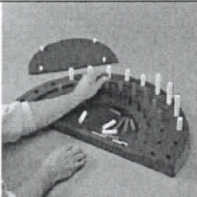
| • Electrical stimulation Therapy | Yes/No | Comment |
|------------------------------------------------------------------------------------|---------------|---------|
| Manufacture | Manufacture | |
| Model | Model | |
| Origin | Origin | |
| Delivery time | Delivery time | |
| 3years warranty and 10 years availability for spare parts | Yes/No | |
| The system include : rehabilitation. | Yes/No | |
| Electrical stimulation with all stander accessories to be ready to use | Yes/No | |
| 2 channel (independent) | Yes/No | |
| Display: wide and good resolution screen. | Yes/No | |
| User friendly and simple. | Yes/No | |
| With standred accessories and electrodes . | Yes/No | |
| Price include user and service manual | Price | |
| Price include installation and training in site . | | |
| Any update of Software will be free of change if needed after of end the warranty. | | |







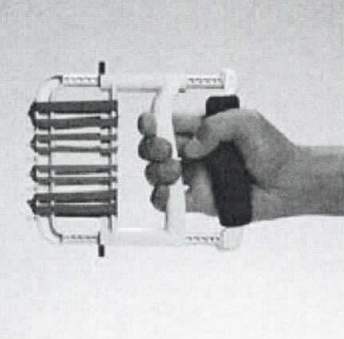
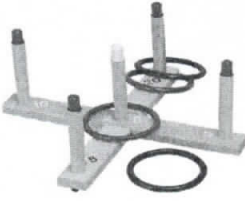



OT equipments Specification

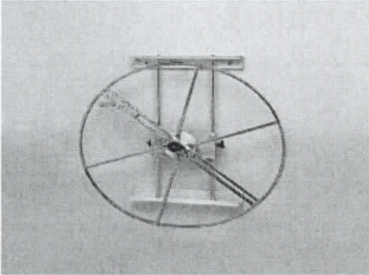

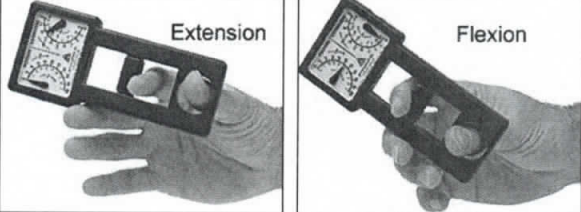

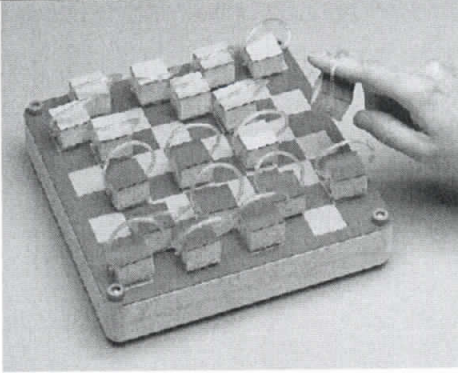
| Item | Specification | Picture-التوضيح |
|----------------------------------------|----------------------------------------------------------------------------------------------------------------------------------------------------------------------------------------------------------------------------------------------------------------------|-------------------------------------------------------------------------------------|
| Power web exerciser Small and large | Hand strengthening exerciser all resistance Color –coded resistance levels Large 14 diameter size and small 7 diameter size |  |
| Vertical Ring Tree | Use for increasing range of motion, eye/hand coordination, manipulation, endurance and sequencing. Includes 6 plastics rods 3.18 high and 3.13 rods Includes 12 rings for each rod |  |
| Single Curved Shoulder Arc | 29" at its highest point, arc includes 24 movable colored tabs for range of motion exercises, crossing the midline, eye/hand coordination and pinch strengthening. base has two holes for optional tabletop attachment or can b secured using clamps or vice grip |  |
| Semi – Circular Peg Board. | Use to increase upper – extremity ROM, strength, coordination and endurance, improve cognitive and visual skills. 3 tiers hold 43 pegs Pegs comes in 2 lengths and three diameter |  |
| Cando twist bend bar | Resistance portable exerciser |  |
| Arm combo skate | Skate for mobilizing elbow and shoulder |  |
| Incline Board | Can be positioned at varying angles, used unilaterally or bilaterally . Weight may be added to the box to give resistance. |  |
| Rolyan Stacking Cones | Washable, non – toxic and impact resistant acrylic cones are 4 -1/4" high with a 2 -1/2 base diameter. |  |

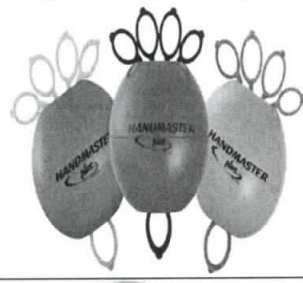
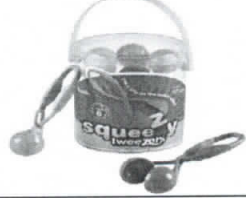
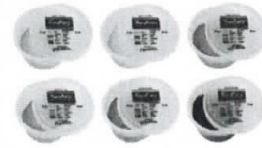

| Item | Specification | Picture- للتوضيح |
|-------------------------------------------------------------------------------------------------------------------------------------|-----------------------------------------------------------------------------------------------------------------------------------------------------------------------------------------------------------------------------------------------------------------------------------------------------------------------------------------------------------------|--------------------------------------------------------------------------------------|
| Egg Shaped Hand Exercisers Soft (purple), 10 Pack Medium (green), 10 Pack Firm (orange), 10 Pack X-Soft (pink), 10 Pack | Comfortable egg shape. Slow recovery of rubber helps strengthen specific finger or thumb. Washable "eggs" leave no messy residue |  |
| Easy Grip Pegs/Boards | Colorful 1-7/8" high knob – shaped plastic pegs easy to grasp and stack. Jumbo pegs provides easier manipulation. + 25 – hole rubber – like board. |  |
| Handmaster Plus 3 Pack - One each soft, medium, and firm. | Provides a complete reciprocal muscle group exercise for the hand through full, natural planes of motion. Great for stroke rehabilitation as well as treating carpal tunnel syndrome and tennis elbow. Contains one resistant ball, two flexible cords (for varying hand sizes) and complete instructions. |  |
| Ergonomic Hand Exerciser | Anatomically designed handle is padded and contoured to fit comfortably in the palm. Lightweight frame adjusts easily for blocking flexion and extension and permits a custom fit for various sized hands. Includes four pairs of graded, color-coded latex-free rubber bands, which can be changed quickly to adjust resistance. |  |
| Champion Sports Ring Toss Set | <ul style="list-style-type: none"> Play the classic game of ring toss at your very own tail gate party, camping trip, or backyard BBQ! Great for improving hand-eye coordination, precision, accuracy, and a child's basic addition skills, the Ring Toss Set from Champion Sports includes 5 pegs with score numbers and 4 rings in 2 different |  |



| Item | Specification | Picture-التوضيح |
|------------------------------------------|------------------------------------------------------------------------------------------------------------------------------------------------------------------------------------------------------------------------------------------------------------------------------------|--------------------------------------------------------------------------------------|
| | <p>colors for competitive play. The peg and peg board are constructed of wood making it perfect for indoor or outdoor play.</p> <p>Product Dimensions: 6.4 x 17.2 x 2.2 inches ; 1 ounces</p> | |
| Finger weight exerciser | <p>Weight belts for each finger Each weight is adjustable with 3-10 gram insert</p> |  |
| Adjustable weight | <p>Weight is varied by inserting or removing the individual weight packets Consists of 5 weight packets and weight shell</p> |  |
| Cando vinyl coated cast – iron dumbbells | <p>Vinyl coated color-coded cast iron dumb-bells are ideal for upper body exercise</p> |  |
| Shoulder wheel | <p>Range of motion arc can be varied from 10 to 39 by moving handle Resistance varied by turning resistance knob Height of unit can adjust 26 to accommodate seated and standing therapy</p> |  |
| Upper & Lower Extremity Systems | <p>EP20M SYSTEM The wireless EP20M system includes all the components to make one complete patient evaluation and exercise station for upper and lower extremity rehabilitation.</p> |  |
| Finger flexion/extension gauge | <p>This unique lightweight plastic pinch gauge measures both finger flexion and extension. Separate scales record each measurement in both pounds and kilograms. Maximum reading remains until reset. Flexion capacity 20 pounds. Extension capacity 5 pounds.</p> |  |

| Item | Specification | Picture- للتوضيح |
|---------------------------------------|----------------------------------------------------------------------------------------------------------------------------------------------------------------------------------------------------------------------------------------------------------------------------------------------------------------------------------------------------------------------------------------------------|---------------------------------------------------------------------------------------------------------------------------------------------------------------------------|
| <p>Finger Extension Remedial Game</p> | <p>One side of the board is a checker game and the other side is a solitaire jumping game.</p> <p>Ideal for active finger extension.</p> <p>Each playing surface has loop material, while the 32 square checkers have hook material.</p> <p>For active extension exercise, position a finger in the soft, vinyl checker loop and pull the checkers away from the board.</p> <p>Color may vary.</p> |  |
| <p>Tape Measure</p> | <p>Reads in inches and centimeters</p> <p>Locks in place until reset button is pressed</p> <p>5' length</p> |  |
| <p>VariGrip</p> | <p>. VariGrip is the only exerciser with the patented ability to adjust the resistance level in each individual finger, allowing you to customize your workout specifically for your needs.</p> |  |
| <p>Hand master plus</p> | <p>Hand Master Plus™ strengthens the 9 muscles that close the hand and the 9 muscles to open the hand. The result is maximum strength, balance and better blood flow to the hand, wrist and elbow.</p> |  |
| <p>squeezing bubble tweezers</p> | <p>Learning Resources Squeezy Tweezers, Fine Motor Tools for Toddlers, Assorted Colors, Set</p> |  |
| <p>Therapatty</p> | <ul style="list-style-type: none"> • Active Recovery for climbers • 6-pack of putty, varying from Super Soft to Super Hard |   |

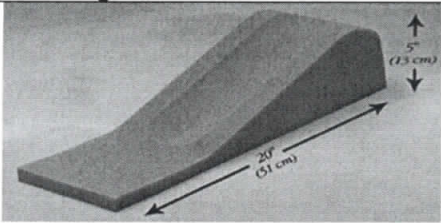
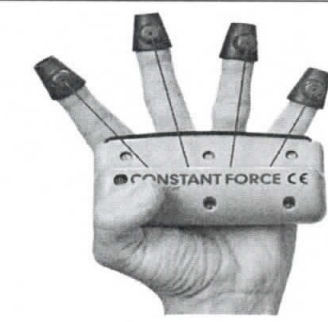





| Item | Specification | Picture- للتوضيح |
|------------------------------------------|-----------------------------------------------------------------------------------------------------------------------------------------------------------------------------------------------------------------------------------------------------------------------------------------------------------------------------------------------------------------------------|--------------------------------------------------------------------------------------|
| theraband | This TheraBand Resistance Band Set contains professional latex elastic bands that are perfect for for upper & lower body and core exercise, physical therapy, lower pilates, at-home workouts, and rehabilitation. It is a yellow, red and green beginner set. |  |
| Metal Goniometer - 6-piece Set with Case | <ul style="list-style-type: none"> - Set of 6 Baseline® goniometers includes the following metal goniometers: - 1 of 6" 180° - 1 of 14" 180° - 1 of 14" 360° - 1 of 8" 180° - 1 of 6" finger goniometer - 1 of x-ray goniometer: 8" 180°. - All 6 instruments are in a protective carry case. |  |
| Finger Goniometer, Metal, Deluxe, 6" | <p>Measures range-of-motion of small joints</p> <p>Deluxe 6" stainless steel finger goniometer</p> <p>Extra-large head</p> <p>Two 180° opposing scales</p> <p>Measures in 5° increments</p> |  |
| Physio ball | The Physio ball is a specific tool to foster recovery from neurological and orthopedic pathologies, a valuable support in treating muscular dystrophy and for rehabilitation and analgesic gymnastic. It is used for strengthening and maintenance motor activities, within the Pilates method, and for functional and athletic training. |  |
| Tactile physio ball | Therapeutic use, especially for those who have problems with balance and coordination. |  |



| Item | Specification | Picture-التوضيح |
|-----------------------------------------------------------------------|-----------------------------------------------------------------------------------------------------------------------------------------------------------------------------------------------------------------------------------------------------------------------------------------------------------------------------------------------------------------------------------------------------------------------------------------------------------------------------------------------------------------------------------------------------------------------------------------------------------------------------------------------------------------------------------------------------------------------------------------------------------------------------------------|-------------------------------------------------------------------------------------|
| <p>Arm Support for Hand Elevation</p> | <p>Designed to elevate the user's injured or weakened arm and hand to help reduce pain and edema Constructed with comfortably solid, open-cell dense foam Will maintain the user's hand at a 5" height above a tabletop to place the hand above the level of the user's heart The arm support is 20" long and 5 1/2" wide to fit most size individuals Will safely fit on a table, bed, lapboard without slipping</p> |  |
| <p>Dynatomy constsnt force X-tend</p> | <p>3 RESISTANCE LEVELS Healthy extensor muscles improve performance by increasing range of motion, circulation, speed, strength, endurance and dexterity for fingers, hands, wrists and forearms. Unlike elastic-based extensor exercisers that increase in resistance the further the unit is extended, the patent-pending Constant Force X-Tend uses retractable-based resistance, which keeps a constant level of resistance from start to finish, regardless of how far the unit is extended. Based on Certified Hand Therapist feedback, Constant Force X-Tend is ergonomically designed and works the intrinsic and extrinsic extensors of the hand, and can isolate MP/PIP/DIP joint motion.</p> |  |
| <p>Variable resistance exerciser for thumb and individual fingers</p> | <p>The VariGrip UNO features patented variable resistance technology, providing customized resistance for both flexion and extension of the thumb or any individual finger, thus improving strength, endurance, circulation and range of motion more effectively.</p> |  |

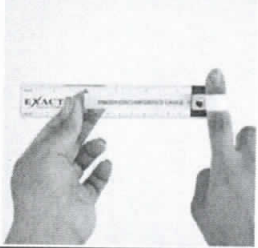

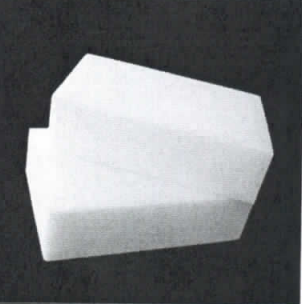

| Item | Specification | Picture- للتوضيح |
|------------------------------------|------------------------------------------------------------------------------------------------------------------------------------------------------------------------------------------------------------------------------------------------------------------------------------------------------------------------------------------------------------------------------------------------------------------------------------------------------------------------------------------------------------|-----------------------------------------------------------------------------------|
| Sensory Stimulation Activities Kit | <p>– The Maddak Sensory Stimulation Activities Kit is a comprehensive sensory and cognitive therapy tool kit with more than 90 age-appropriate sensory activities including auditory, visual, olfactory, gustatory and tactile stimuli. The 13-1/2"H x 15-1/2"W x 6-1/4"D (34 x 39 x 16cm) carrying case holds 31 functional, safe materials to stimulate the senses. Included manual contains sensorimotor assessment procedures, treatment guidelines and goals, activities and documentation forms.</p> |  |

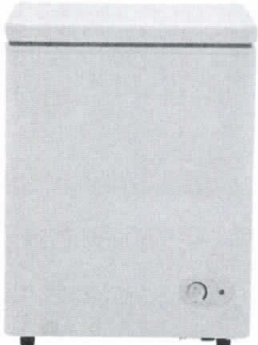
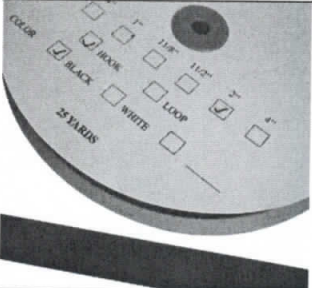

| Item | specification | Picture- للتوضيح |
|----------------------------------|----------------------------------------------------------------------------------------------------------------------------------------------------------------------------------------------------------|---------------------------------------------------------------------------------------|
| Grooved Pegboard | This manipulative dexterity test contains twenty-five holes with randomly positioned slots and pegs which have a key along one side. Pegs must be rotated to match the hole before they can be inserted. |  |
| Tape measure | fabric |  |
| Finger Circumference Gauge | |  |
| Thermotherapy Paraffin Bath | |  |
| Paraffin Wax Box:6LB | |  |
| Cold Packs | |  |

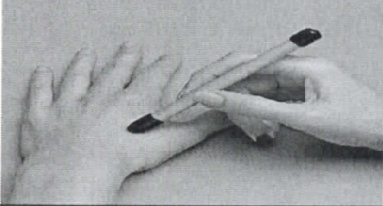
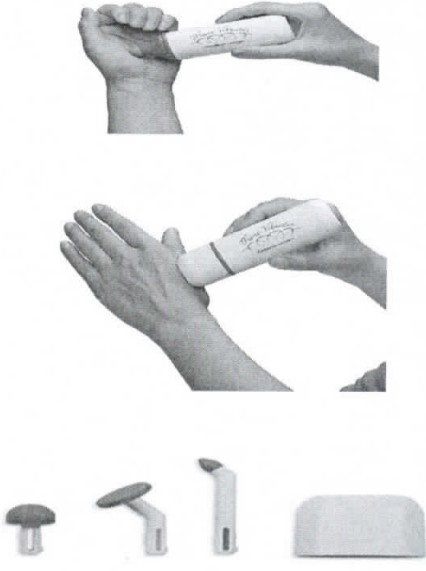
| Item | specification | Picture- للتوضيح |
|-----------------------------|---------------|---------------------------------------------------------------------------------------|
| HotPac | |  |
| Hydrocollator Heating Units | |  |
| Chilling Unite | |  |
| Self-adhesive hook and loop | |  |

| Item | Specification | Picture-التوضيح |
|-----------------------------------------------|-------------------------------------------------------------------------------------------------------------------------------------------------------|--------------------------------------------------------------------------------------|
| Scar Tissue Massage Tool | 3/8" (9.5 mm) Small Diameter 5/8" (16 mm) Large Diameter |  |
| Norco Mini Vibrator Multi Head Massager | 5" (13cm) Length 5.5 oz. Weight 92 cycles per second Vibration Speed 0.06 mm Amplitude 90 days Warranty |  |
| Putty-like Elastomer Kits for Scar Treatments | Quantit: (1) A and (1) B component: 12oz or 32oz Fluid Ounce Options Comes in two separate materials that set up when mixed together |  |

 دائرة الاعتماد والمشتريات
 AUTHORITY FOR ACADEMIC ACCREDITATION AND PURCHASING

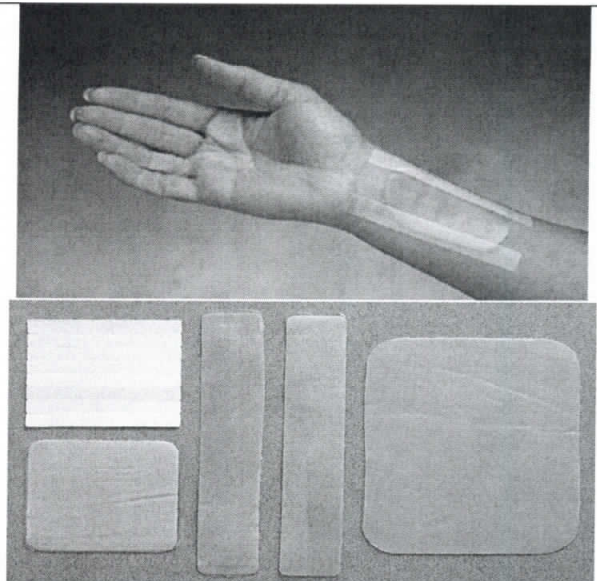
| Silipos Gel Sheet for Scar Management | Item Number: | Dimensions: | Thickness | |
|---------------------------------------|--------------|---------------------------|--------------|------------------------------------------------------------------------------------|
| | 1.NC52505 | 4" x 4" (10 x 10cm) | 1/16"(.2cm) |  |
| | 2. NC52505 | 5-1/2" x 8" (14 x 20cm) | 1/16" (.2cm) | |
| | 3. NC52505 | 1-1/2" x 10" (3.8 x 25cm) | 1/16" (.2cm) | |
| | | | | |

scar massage tool

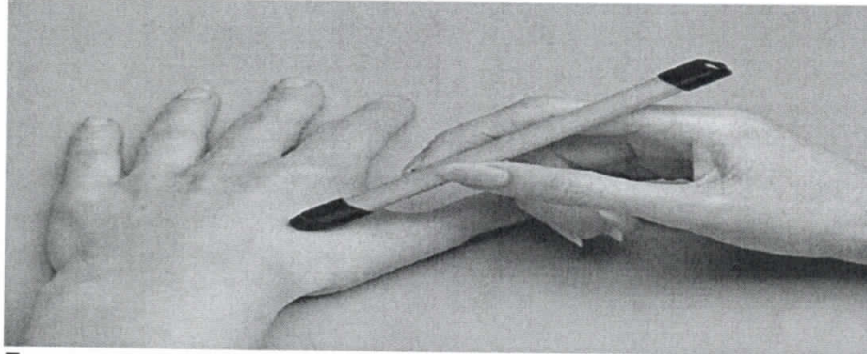

Easy to use, this scar massage tool provides efficacious relief, softening, and desensitization for a wide range of different scar tissues.

- Effective massage tool softens and desensitizes scar tissues
- Can be used at home, or in professional therapy practices for comprehensive scar management
- Durable wooden design, with rubber tips to more accurately locate adhesions
- Available in two different sizes to provide precise therapy for unique requirements
- Aids in breaking up all types of hardened scar tissue, including hypertrophic and keloid



Norco Mini Vibrator Multi Head Massager

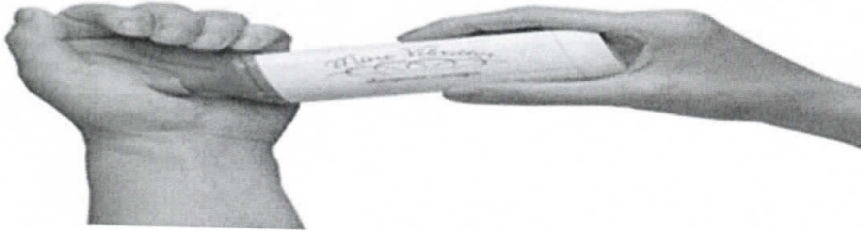

this personal massager is conveniently compact and includes three massage heads suitable for applications such as scar massage, desensitization, and muscle stimulation.
Small, compact size for convenient storage and portability
Includes three massage head options to suit treatment area and application
Provides versatile, effective massage therapy for a variety of applications
Quiet operation to prevent the drawing of unwanted attention
Fits comfortably in the palm of your hand

Topigel Silicone Gel Sheeting

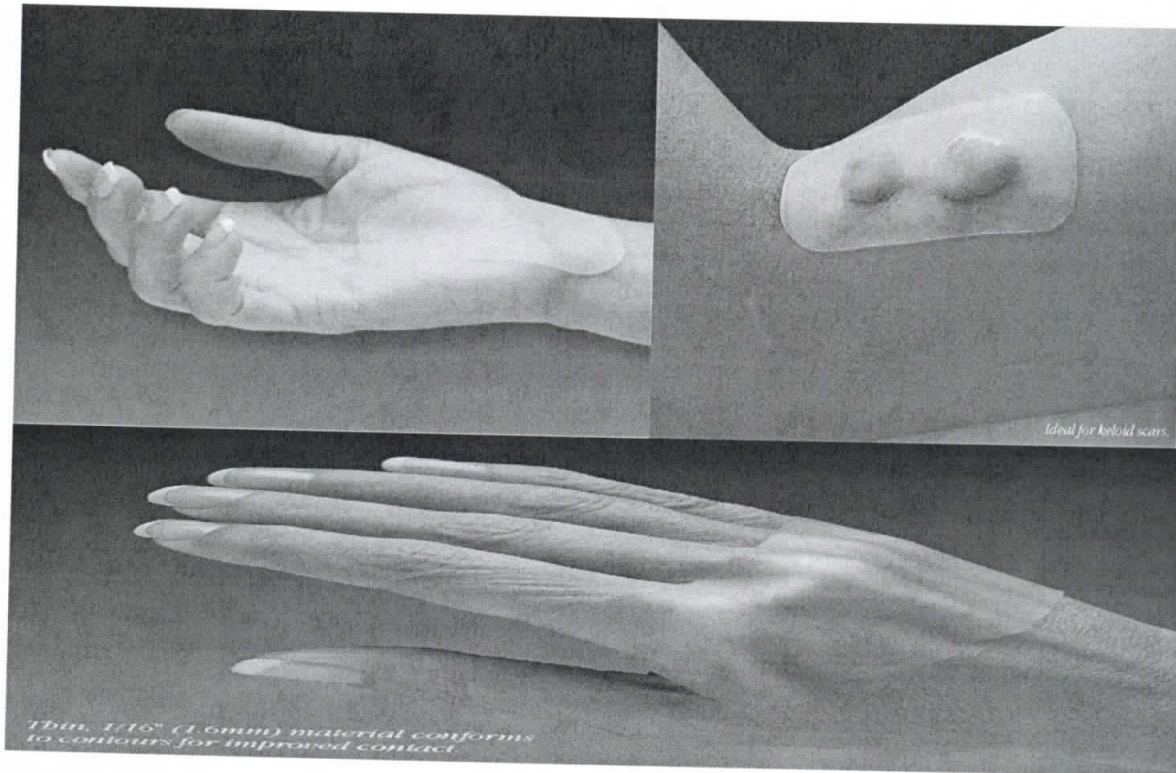

Cica-Care Silicone Gel Sheet



Cica-Care Silicone Gel Sheeting is a self-adhesive, durable silicone sheet. For management of both new and existing hypertrophic and keloid scars.

Designed to provide a reliable treatment for scar tissue.

Reusable, cost-effective, and easy solution for scar treatment.

Ideal for management of new and existing hypertrophic and keloid scars.

Self-adhesive, durable silicone sheet is convenient and easy to use.

Thin, flexible design is comfortable and conformable for reliability.

Otoform Kc Scar Remodeling and Healing Elastomer



This elastometer is the perfect solution for scar remodeling and healing, offering a unique formulation that sets up easily at room temperature and then can be molded to shape for simple application.

- Ideal solution for scar remodeling and healing.
- Once combined the resulting paste can be easily formed to shape.
- Unmixed formulation is longer-lasting than pre-mixed options.
- Easily sets up at room temperature in about four minutes.
- Can be easily used with splints, burn garments, and gloves.



Mepiform Soft Silicone Gel Sheeting

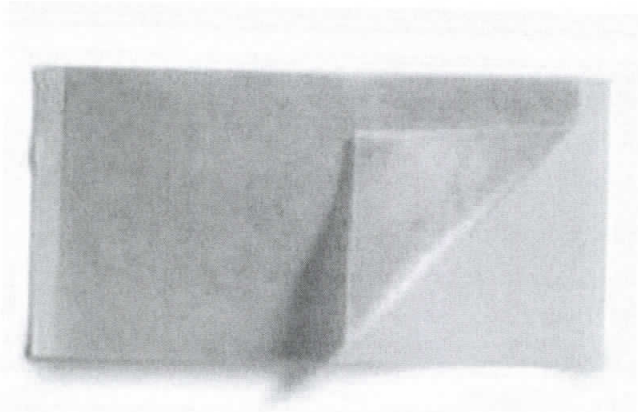

Mepiform Soft Silicone Gel Sheeting is self-adherent silicone dressing for scar management featuring Safetac technology.

-
-
-
-

Designed to enable effective management of old and new scars.
Self-adherent dressing enables convenient treatment.
Can be easily worn 3 - 7 days for versatile, discreet treatment.
Thin, flexible, soft silicone gel sheeting for easy use.

Putty-like Elastomer Kits for Scar Treatments

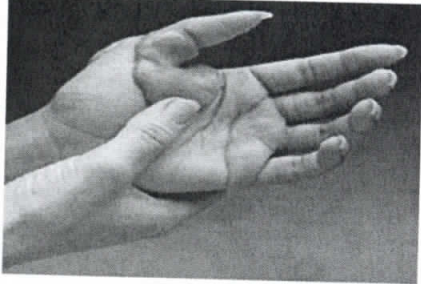

- Easy to mix
- Softens and flattens hypertrophic scarring
- Dense consistency
- Sets up in three minutes

Comes in two separate materials that set up when mixed together



Silipos Gel Sheet for Scar Management

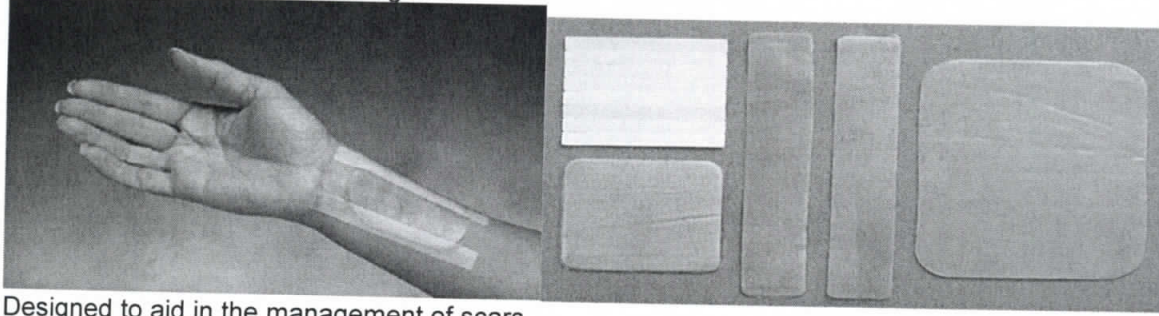



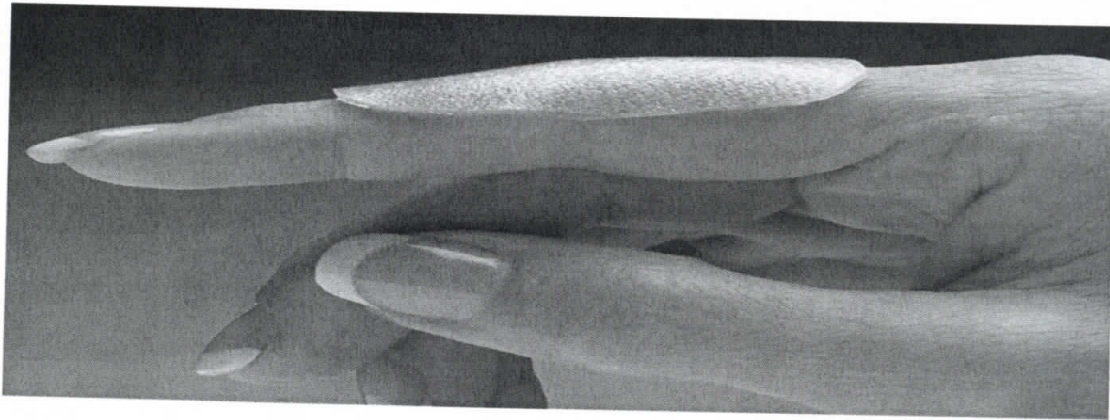

Designed to aid in the management of scars.



- Self-adhesive gel sheeting enables easy application.
- Gel sheet contains medical-grade mineral oil that dissipates to the skin.
- Ideal for post-surgical scars, skin-grafts, burns, and tissue expansion.
- Reusable sheets can be easily hand-washed to maintain hygiene.







Assistive device and technology Specification

| Item | Specification | Picture-للتوضيح |
|---------------------------------------------------------|--------------------------------------------------------------------------------------------------------------------------------------------------------------------------------------------------------------------------------------------------------------------------------------------------------------------------------------------------------------------------------------------------------------------|-------------------------------------------------------------------------------------|
| FOREARM CRUTCHES (EACH) | <p>height adjustable to fit users who are 4'7" to 6'8".</p> <p>crutch weighs just 1.32 lbs and has a maximum weight capacity of 286 lbs</p> <p>World's lightest crutch with integrated shock absorber (1.32 lbs each)</p> <p>Durable, epoxy coated aluminum legs adjusts 28.4-39"</p> <p>Ultra-soft replaceable grips with easy push button release</p> <p>Replaceable, anti-slip crutch tips ensure stability</p> |  |
| BARIATRIC CRUTCHES , 1 PAIR | <p>Heavy duty steel construction</p> <p>Easy push-button height adjustment</p> <p>Contoured underarm and hand grips</p> <p>Readily adjustable handgrip position</p> <p>Weight capacity: 600 lbs</p> |  |
| DRIVE HEAVY DUTY BARIATRIC WALKER | <p>Height adjustments: 32"-39"</p> <p>Precision design provides strength while adding minimal weight</p> <p>Vinyl contoured handgrip weighs: 9 lbs.</p> <p>Weight capacity: 500 lbs.</p> |  |
| MEDLINE EXTRA-WIDE TWO-BUTTON HEAVY DUTY WHEELED WALKER | <p>Approximate user height: 5'2" - 6'6"</p> <p>Height adjustments: 33.5"-43.25"</p> <p>Width between handles: 21"</p> <p>Easy push button mechanisms</p> <p>Folds to 4.5" for easy storage and transportation</p> <p>PVC handgrips offer additional comfort</p> <p>Weighs: 12 lbs.</p> <p>Weight Capacity: 500 lbs.</p> |  |



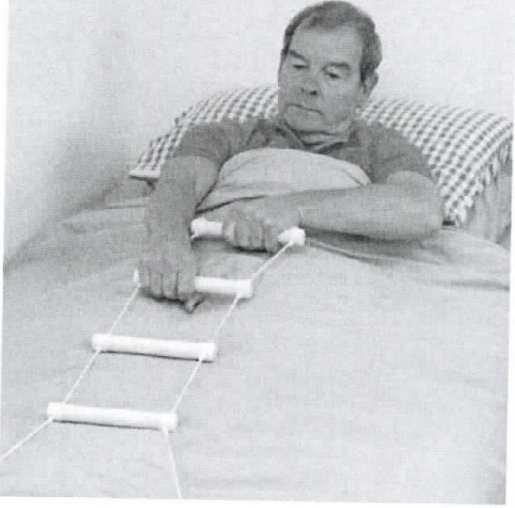
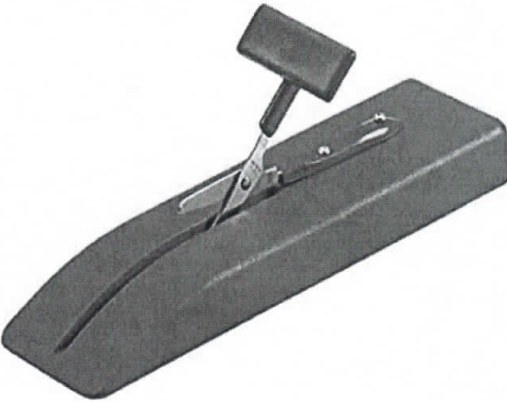

| Item | Specification | Picture- للتوضيح |
|-----------------------------------------------------------------|-----------------------------------------------------------------------------------------------------------------------------------------------------------------------------------------------------------------------------------------------------------------------------------------------------------------------------------------------------------------------------------------------------------------------------------------------------------------------------------------------------------------------------------------------------------------------------------------------------------------------------------------------------------------------------------------------------------------------------------------------------------------------------------------------------------------------------------------------------------------------------------------------------------------------------------------------------------------------------------------------------------------------------------------------------------------------|-------------------------------------------------------------------------------------|
| SCREW-TYPE MOBILE STOOL WITH NO BACK (SPECIFY UPHOLSTERY COLOR) | <p>Dimensions: 14" x 18-24" x 14"</p> <p>Weight: 16 lbs</p> <p>Weight Capacity: 250 lbs. Its seat measures 14 inches in diameter, with a thickness of 4 inches</p> |  |
| Smart 150 Folding Mobile Hoist | <p>One Smart 150 Folding Mobile Hoist</p> <p>Incredibly lightweight, folding mobile hoist</p> <p>Folds to compact size for easy transportation</p> <p>Perfect for users or homecarers that travel</p> <p>Ideal for both the home or care environment</p> <p>Push handle for excellent manoeuvrability</p> <p>Four braked castors for safety and stability</p> <p>Fitted with four point spreader bar as standard</p> <p>Rechargeable battery allows for constant use</p> <p>Compact size for use in the narrowest of spaces</p> <p>Lifts from the floor, ideal in emergency situations</p> <p>Hoist height: 1320mm (52")</p> <p>Hoist length: 1160mm (45.5")</p> <p>Hoist width: 660mm (26")</p> <p>Width with legs open: 920mm (36.25")</p> <p>Leg height: 110mm (4.5")</p> <p>Lifting height: 270mm - 1680mm (10.5" - 66")</p> <p>Hoist length when folded: 1160mm (45.5")</p> <p>Hoist height when folded: 360mm (14")</p> <p>Hoist width when folded: 190mm (18.75")</p> <p>Folding hoist weight: 26 kgs (4 st)</p> <p>Maximum user weight: 150 kgs (23.5 st)</p> |  |

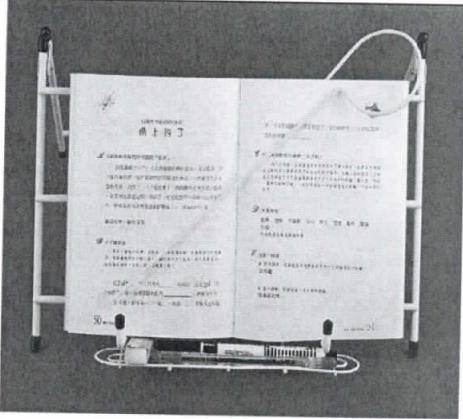
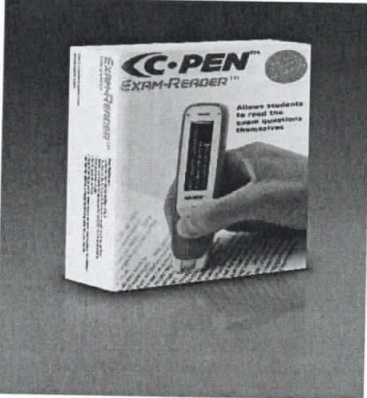
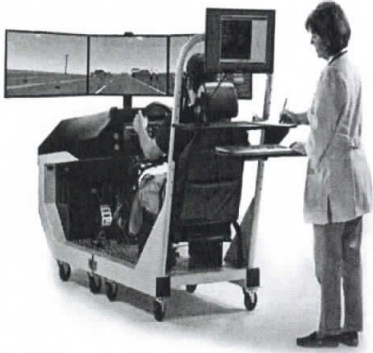

| Item | Specification | Picture-التوضيح |
|------------------------------------------------------|-------------------------------------------------------------------------------------------------------------------------------------------------------------------------------------------------------------------------------------------------------------------------------------------------------------------------------------------------------------------------------------------------------------------------------------------------------|--------------------------------------------------------------------------------------|
| MANUAL TEENAGER & ADULT CHAIR | <p>Seat Dimensions (Y) 47 x 49cm</p> <p>Seat Depth Adjustment: 33-49cm</p> <p>Seat Angle: -6/+3 Degrees</p> <p>Backrest Dimensions (Y) 43 X 45cm</p> <p>Backrest Angle -20/+6 degrees</p> <p>Armrest Pad Size 9 x 30cm</p> <p>Armrest Height 0-24cm</p> <p>0-34cm</p> <p>Distance between Armrests 41-55cm</p> <p>Footrest Length 22-32cm</p> <p>27-43cm</p> <p>Weight 23kg</p> <p>Maximum Load 160kg</p> |  |
| Kinesio Tex Taping Kit | <p>kit contains all you need to prepare, apply, and remove the Kinesio tape</p> <p>The 100% cotton, 100% acrylic adhesive construction provides flexible support to the muscles during physical activity</p> <p>Tape helps to alleviate discomfort and facilitates lymphatic drainage by microscopically lifting the skin</p> <p>Does not limit range of motion</p> <p>Hypoallergenic, water resistant, and latex free</p> |  |

| Item | Specification | Picture- للتوضيح |
|-----------------------------------------------------|----------------------------------------------------------------------------------------------------------------------------------------------------------------------------------------------------------------------------------------------------------------------------------------------------------------------------------------------------------------------------------------------------------------------------------------------------------------------------------------------------------------------------------------------------------------------------------------------------------------------------------------------------------------------|--------------------------------------------------------------------------------------|
| Rope Ladder Bed Hoist Healthcare | <p>Rung length: 200mm (8")</p> <p>Rung diameter: 25mm (1")</p> <p>Cord length: 3 metres (9 ft 10")</p> <p>Rope ladder weight: 285 gms (10 ozs)</p> <p>Maximum user weight: 70 kgs (11 st)</p> |  |
| Mounted Table Top Scissor (Plastic base) 45mm blade | <p>Hidden spring: This is now integral to the blade and not visible whilst still providing the same self-opening action</p> <p>Large "T" shaped handles: Designed for use on table-top to give good stability and leverage</p> <p>High quality stainless steel blade: Provides longevity and cuts through paper with ease</p> <p>Plastic base with rubber feet: Lightweight yet stable</p> <p>Complete with zip case: Attractive and handy for storing other small items such as pencil grips. Keeps the scissors safe when not in use</p> |  |
| PenAgain Ergosof Pen - Black | <p>omfortable "No Grip" design.</p> <p>Refillable ink cartridges (The new Ergo-Sof PenAgain and the Original PenAgain use a non-pressurized MED 1.0 mm black ink cartridge).</p> <p>wide variety of colors & styles to suit your needs.</p> <p>With pocket clip, retractable cap, easier refill replacement and a streamlined ergonomic look.</p> <p>The Penagain does what no one has been able to do since the world threw away the quill and grabbed a ball point pen. The Penagain quite simply revolutionizes the way you write. The Penagain is a must have for anyone who writes a great deal and is beneficial to the occasional note taker as well.</p> |  |



| Item | Specification | Picture-التوضيح |
|------------------------------------------------------------------------------------------------------------------------|----------------------------------------------------------------------------------------------------------------------------------------------------------------------------------------------------------------------------------------------------------------------------------------------------------------------------------------------------------------------------------------------------------------------------------------------------------------------------------------------------------------------------------------------------------------------------------------------------------------------------------------|--------------------------------------------------------------------------------------------------------------------------------------------------------------------------------------------------------------------------------------------------------------------------------------------------------------------------------------------------------------------------------------------------|
| <p>Folding Reading Stand - Folding Book Holder - Book & Magazine Holder - Reading aids from Bayliss Mobility)</p> | <p>This reading stand is ideal for those who find it difficult to hold books and magazines when reading. Simply stand the book and magazine in the holder and read, all you need to do is turn the pages. The stand can be folded easily for storage or travel and comes complete with a clip to keep the pages open. Size - Length 30cm Width 23.5cm Plastic coated steel. Weight 520g. The price of this item is shown exclusive of VAT. If you are purchasing this book stand for someone who is disabled or suffers from a chronic illness you are eligible for VAT relief. We will message you after you purchase for details</p> |  |
| <p>C-Pen Exam Reader</p> | <p>Allows students with dyslexia, or other reading difficulties, to take written exams. Bolsters reading independence Totally portable, pocket-sized device reads text out aloud with an English human-like digital voice Reads with a human-like digital voice in multiple English accents and different languages including: French, Spanish, Italian, German, and more Can be used in exams as an alternative to a human reader, Quick, long-lasting charge via USB Package includes ExamReader, carry case, USB cable, instruction manual, and earbuds</p> |  |
| <p>Driving simulator</p> |  | <ul style="list-style-type: none"> -Hand Controls -Steering Wheel Knobs -Knobs with Indicator -Indicator Handle -Panoramic Mirror -Gear Stick Handle -Seat Harnesses -Rotating Seat -Left Accelerator -Ultra-Light Steering Wheel -Telescope Steering Wheel -Ultra-Light Brake |





| Item | Specification | Picture- للتوضيح |
|--------------------------------------------|-------------------------------------------------------------------------------------|--------------------------------------------------------------------------------------------------------------------------------------------------------------------------------------------------------------------------------------------------------------------------------------------------------------------------------------------------------|
| Bionness |  | <p>Hand Rehabilitation System to improve movement and tone for patients with CNS damage</p> |
| Fine motor and upper limb training station |  | <ul style="list-style-type: none"> -Robotics and sensor-based rehabilitation devices for use with either hand. -Assistive and interactive therapies for individual fingers and thumbs movements. - Can be used by adults and children. - Spasticity management. - Objective assessments and reports |
| Upper extremity virtual/ smart training |  | <ul style="list-style-type: none"> -Robotic and sensor-based rehabilitation device -Unilateral and bilateral therapy -Assistive and interactive therapies for the whole arm -Applicable for adults and children |

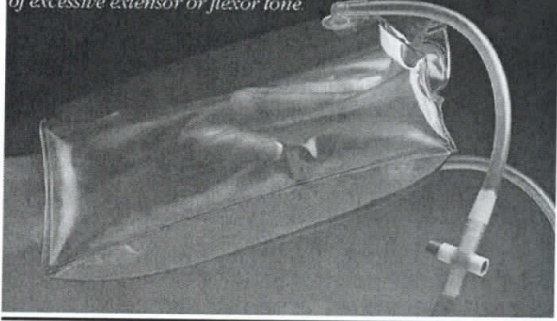

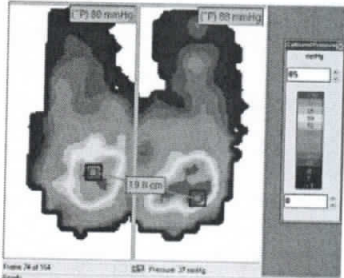

| Item | Specification | Picture- للتوضيح |
|------------------------|------------------------------------------------------------------------------------|-----------------------------------------------------------------------------------------------------------------------------------------------------------------------------------------------------------------------------------------------------------------------------------------------------------------------------------------------------------------------------------------------------------------------------------------------------------------------------------------------------------------------------------------------------------------------------------------------------------------------------------------------------------------------------------------------------------------------------------------------------------------------------------------------------------------------------------------------------------------------------------------------------------------|
| Smart exercise station |  | <p>Sensor-based hand and upper extremity rehabilitation and assessment station.</p> <p>Objective assessments, monitoring and reporting system</p> |
| Smart table |  | <ul style="list-style-type: none"> -Highly adaptable -Provides working space for more than one person -Unilateral and bilateral training -Offers full documentation and tracking of the therapy -Interactive applications with real objects, force control and touch applications -Neurology, orthopedics, geriatrics und pediatrics -Task-oriented rehabilitation with sensor-based surface and real objects -Force detection with pressure and pull to assess -Bilateral work enables a better rewiring of the hemispheres -Trains gross-motor skills, fine-motor-skills, rotation movement, hand-eye coordination, and motoric coordination -Especially for patients with deficits in motor function, concentration, selective attention, visual-spatial perception, and spatial-perceptive ability |







| Item | Specification | Picture- للتوضيح |
|------------------|--------------------------------------------------------------------------------------------------------------------------------------------------------------------------------------------------------------------------------------------------------------------------------------------------------------------------------------------------------------------------------------------------------------------------------------------------------------------------|--------------------------------------------------------------------------------------------------------------------------------------------------------------------------------------------------------------------------------------------------------------------------------------------------------------------------------------------------------------------------------------------------------|
| Fluidotherapy |  | <p>Single Extremity or Double Extremity Fluidotherapy units</p> <ul style="list-style-type: none"> • Continuous and Pulse modes of operation • Treatment times can be set from 1-99 minutes • Operating temperatures to 52° C • Adjustable air speeds of 0-100% • Units are provided with a wake-up pre-heat timer to warm up the unit prior to use |
| Adult air splint | <ul style="list-style-type: none"> • Durable PVC sheeting is supportive and holds up through repeated use. • Inflates to immobilize and support limbs with gentle air pressure. • Can fit easily in a first aid kit when deflated and can be applied easily. • Plastic zipper closure makes for easy donning and doffing of the air splint. • Option of single or double chamber design accommodate a range of needs. | <p><i>Two individually inflated chambers allow for specific management of excessive extensor or flexor tone.</i></p> <p><i>Double-chamber splint</i></p>  |
| OVER TOILET AID | <ul style="list-style-type: none"> • Safe Working Load (S.W.L) of 175kg. Tested to AS/NZS3973.7:2009 • Raised armrests – Assist the user transferring on and off the Over Toilet Aid • Additional height increments on one leg – Accommodates |  |

| Item | Specification | Picture- للتوضيح |
|-----------------------------------------------------|---------------------------------------------------------------------------------------------------------------------------------------------------------------------------------------------------------------------------------------------------------------------------------------------------------------------------------------------------------------------------------------------------------------------------------------------------------------------------------------------------------------------------------------------------------------------------------------------|--------------------------------------------------------------------------------------|
| Guardian Padded Transfer Bench with Commode Opening | <ul style="list-style-type: none"> • Thick, high-density foam cushions offer comfort. • High-density seating is supportive and won't bottom out. • Commode opening provides easy access for hygiene tasks. • Side arm provides added stability for users while transferring. • Suction cup foot pieces secure the bench to the tub floor for stability. |  |
| Seat pressure mapping | <ul style="list-style-type: none"> • An outstanding tool to evaluate the interaction between the human body and the surface that supports it in seats like e.g. wheelchair seat cushions, working and relax chairs. |  |
| raised toilet seat | <ul style="list-style-type: none"> • Lightweight, portable, and easy-to-clean heavy-duty molded plastic adds 5" to height of toilet seat • Simple locking device provides a reliable, secure fit on almost any toilet with tool-free installation • Easily add or remove supportive metal arms based on personal preference and need. Inside seat width is 8 inches. Inside seat depth is 9 inches • Seat dimensions: 16.5"(D) x 17"(W) x 5"(H); Width between arms: 18"; Overall height: 10"; Weight capacity: 300 pounds. Heavy-duty worm screw |  |

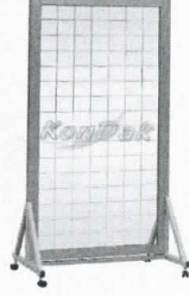
OT Physical Clinic (Furniture and equipments)



| Item | Specification | Picture-التوضيح |
|------------------------------|------------------------------------------------------------------------------------------------------------------------------------------------------------------------------------------------------------------------------------------------------------------------------------------------------------------------------------------------------------------------------------------------------------------------------------------------------------------------------------------------------------------------------------------------------------------------------------------------------------------------------------------|--------------------------------------------------------------------------------------------------------------------------------------------------------------------------------------------------------------------|
| Electric Bobath table AM-641 | <p>The AM-641 Mat Table is made of a welded all steel frame mat platform that has a capacity to lift up to 900 lbs. of weight. You are guaranteed to find the perfect choice for your clinic's needs with its three models and three sizes available to choose from. All of these steel frame mat platforms have welded tubular steel frames and legs with fully furnished and burnished welds. They have a 34 oz. heavy duty vinyl with Permablok 3(R) bacterial protection and 2" firm density foam tops. They also have reduced, seamless corners on upholstered components. Its electric models feature a 120 volts 60 Hz motor.</p> | <p style="text-align: center;">Elektrik </p>  |
| Adjustable therapy table | <p>High-pressure laminate top is durable and strong. Convenient crank handle enables easy height adjustment. Natural oak laminate is sleek, strong, and easy to clean.</p> <p>Length Width</p> |  |
| | |  |

| | | |
|------------------------------------------------|-----------------------------------------------------------------------------------------------------------------------------------|--------------------------------------------------------------------------------------|
| <p>Folding Therapy Mat</p> | |  |
| <p>Portable Mirrors (Different Sizes)</p> | <p>Overall dimensions: 70in H x 24in W x 18in D</p> |  |
| <p>Therapeutic Bean Bag</p> | |  |
| <p>Functional Electrical Stimulation (FES)</p> | <p>(FES) is a treatment that involves the application of a mild electrical stimulus to a muscle that helps it to move better.</p> |  |
| <p>Ultrasound Therapy Machines</p> | <p>Chattanooga's Intelect Legend Ultrasound Machine provides two different ultrasound frequencies: 1MHz and 3.3MHz</p> |  |

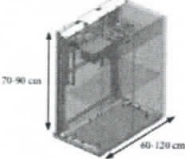
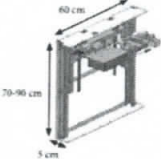
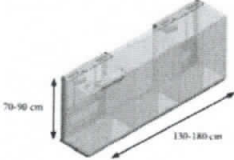
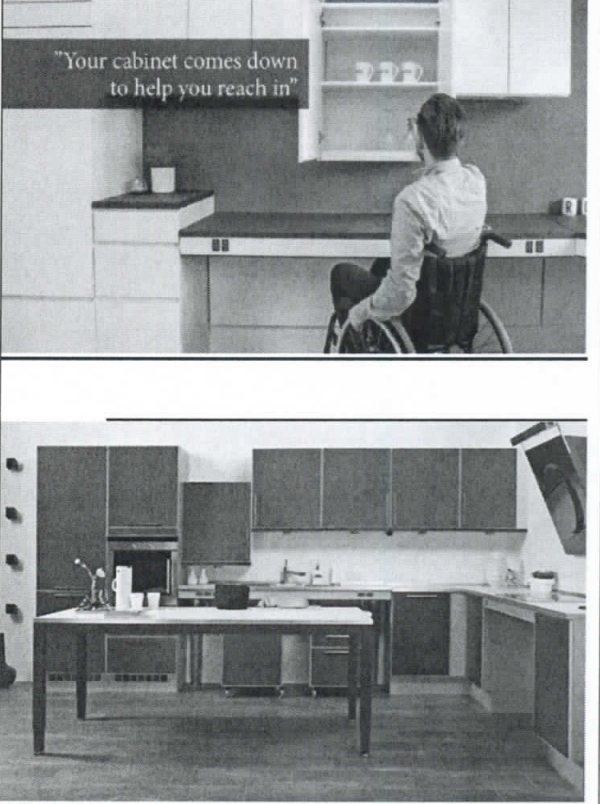
kitchen adaptation

| Item | Specifications | Picture- للتوضيح |
|-----------------------------------|--------------------------------------------------------------------------------------------------------------------------------------------------------------------------------------------------------------------------------------------------------------------------------------------------------------------------------------------------------------------------------------------------------------------------------------------------------------------------------------------------------------------------------------------------------------------------------------------------------------------------------------------------------------------------------------------------------------------------------------------------------------------------------------------------------------------------------------------------------------------------------------------------------------------------------------------------------------------------------------------------------------------------------------------------------------------------------------------------------------------------------------------------------------------------------------------------------------------------------------------------------------------------------------------------------------------------------------------------------------------------------------------------------------------------------------------------------------------------------------------------------------------------------------------------------------------------------------------------------------------------------------------------------------------------------------------------------------------------------------------------------------------------------------------------------------------------------------------------------------------------------------------------------------------------------------------------------------------------------------------------------------------------------------------------------------------------------------------------------------|-------------------------------------------------------------------------------------|
| <p>Verti electric wall frames</p> | <p>Verti electric wall frames raise & lower wall cupboards vertically by up to 30cm. Units are operated simply by pressing a button which is usually located in the fascia or down stand fitted below the worktop.</p> <p>The framework remains completely hidden whilst the wall cupboard is moving.</p> <p>Widths from 40-180cm can be accommodated and standard wall units with a height of 70-90cm can be used.</p> <p>As with all Scanflex electrically operated kitchen frames optional safety devices are recommended. For Verti frames a safety plate is suggested which can even include light fittings if required. These plates prevent accidental crushing of objects placed on the worktop.</p> <p>Verti Electric Frames are ideal for:</p> <ul style="list-style-type: none"> • Social Housing with accessible kitchens for wheelchair users • Adaptations combined with rise & fall worktops • Student Accommodation in a fully inclusive kitchen • Rehab Centres with flexible solutions for disabled people • Food Technology with accessibility for a range of users <div style="display: flex; justify-content: space-around; margin-top: 20px;"> <div data-bbox="370 1224 591 1260"> <p>VertiElectric - frame for 40-50 cm wall unit, 30-40604 - 30-40605</p>  </div> <div data-bbox="737 1224 846 1245"> <p>Unit sizes for wall unit</p>  </div> </div> <hr/> <div style="display: flex; justify-content: space-around; margin-top: 20px;"> <div data-bbox="370 1482 573 1518"> <p>VertiElectric - frame for 60 cm wall unit, 30-40606 - 30-40612</p>  </div> <div data-bbox="737 1482 846 1518"> <p>Unit sizes for wall unit 30-40613 - 30-40618</p>  </div> </div> |  |

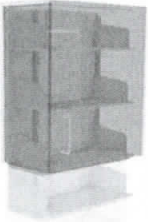
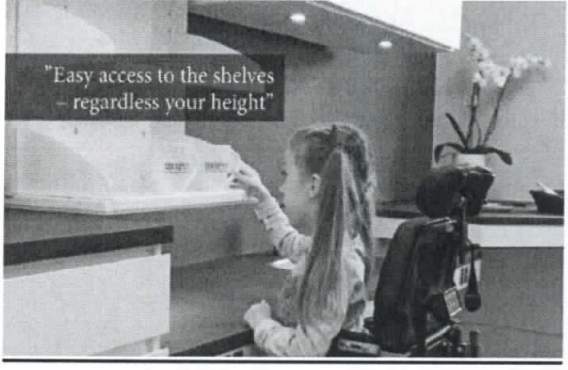
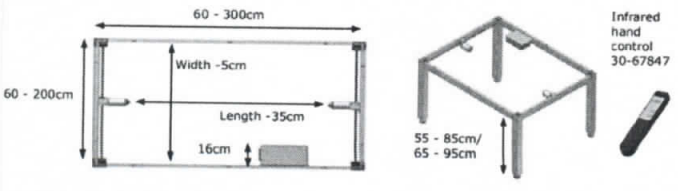

| Item | Specifications | Picture- للتوضيح | | | | | | | | | | | | | | | | | | | | | | | | |
|-----------------------------------|-------------------------------------------------------------------------------------------------------------------------------------------------------------------------------------------------------------------------------------------------------------------------------------------------------------------------------------------------------------------------------------------------------------------------------------------------------------------------------------------------------------------------------------------------------------------------------------------------------------------------------------------------------------------------------------------------------------------------------------------------------------------------------------------------------------------------------------------------------------------------------------------------------------------------------------------------------------------------------------------------------------------------------------------------------------------------------------------------------------------------------------------------------------------------------------------------------------------------------------------------------------------------------------------------------------------------------------------------------------------|--------------------------------------------------------------------------------------|---------|---------|-------|----------|----------|-------|----------|----------|-------|----------|----------|-------|----------|----------|-------|----------|----------|-------|----------|----------|--------|----------|----------|-------------------------------------------------------------------------------------|
| Verti inside electric wall frames | <p>Verti Inside electric frames will convert standard wall units to enable the contents of the cupboard to lower by up to 49.5cm.</p> <p>This allows seated users to be able to access storage easily whilst retaining the original look of the kitchen.</p> <p>Dual safety devices are incorporated so that the frame will stop if it meets an obstruction on the worktop and also if an object that is too tall is placed on the top shelf.</p> <p>The Verti Inside will adapt wall cupboards with widths from 40 – 100cm and is available to suit depths of 26.5cm & 31cm.</p> <p>Vertiinside - wall unit size:</p> <table border="1" data-bbox="370 682 678 913"> <thead> <tr> <th>WIDTH/DEPTH</th> <th>26.5 cm</th> <th>31.0 cm</th> </tr> </thead> <tbody> <tr> <td>40 cm</td> <td>30-40404</td> <td>30-40414</td> </tr> <tr> <td>50 cm</td> <td>30-40405</td> <td>30-40415</td> </tr> <tr> <td>60 cm</td> <td>30-40406</td> <td>30-40416</td> </tr> <tr> <td>70 cm</td> <td>30-40407</td> <td>30-40417</td> </tr> <tr> <td>80 cm</td> <td>30-40408</td> <td>30-40418</td> </tr> <tr> <td>90 cm</td> <td>30-40409</td> <td>30-40419</td> </tr> <tr> <td>100 cm</td> <td>30-40410</td> <td>30-40420</td> </tr> </tbody> </table> <p>Min. wall unit height: 70.4 cm</p>  | WIDTH/DEPTH | 26.5 cm | 31.0 cm | 40 cm | 30-40404 | 30-40414 | 50 cm | 30-40405 | 30-40415 | 60 cm | 30-40406 | 30-40416 | 70 cm | 30-40407 | 30-40417 | 80 cm | 30-40408 | 30-40418 | 90 cm | 30-40409 | 30-40419 | 100 cm | 30-40410 | 30-40420 |  |
| WIDTH/DEPTH | 26.5 cm | 31.0 cm | | | | | | | | | | | | | | | | | | | | | | | | |
| 40 cm | 30-40404 | 30-40414 | | | | | | | | | | | | | | | | | | | | | | | | |
| 50 cm | 30-40405 | 30-40415 | | | | | | | | | | | | | | | | | | | | | | | | |
| 60 cm | 30-40406 | 30-40416 | | | | | | | | | | | | | | | | | | | | | | | | |
| 70 cm | 30-40407 | 30-40417 | | | | | | | | | | | | | | | | | | | | | | | | |
| 80 cm | 30-40408 | 30-40418 | | | | | | | | | | | | | | | | | | | | | | | | |
| 90 cm | 30-40409 | 30-40419 | | | | | | | | | | | | | | | | | | | | | | | | |
| 100 cm | 30-40410 | 30-40420 | | | | | | | | | | | | | | | | | | | | | | | | |
| 4 single table frames | <p>4Single Table frames raise & lower worktops or tabletops with an overall size of up to 300cm x 200cm. 1-1</p> <p>Available in 2 height ranges, 55cm – 85cm & 65cm – 95cm the table frames can be supplied with either manual or electric operation.</p> <p>Accessories include brake wheels (increasing overall height by 6.5cm), safety device on electric versions, battery backup pack & infra-red hand control.</p> <p>4single Table frames are ideal for:</p> <ul style="list-style-type: none"> • <u>Social Housing with accessible kitchens for wheelchair users</u> • <u>Adaptations combined with rise & fall worktops</u> • <u>Student Accommodation in a fully inclusive kitchen</u> • <u>Rehab Centres with flexible solutions for disabled people</u> • <u>Food Technology with accessibility for a range of users</u> <p>4SingleElectric - (height 55-85cm) or (height 65-95cm) 4SingleElectric is also available with a battery solution.</p>  |  | | | | | | | | | | | | | | | | | | | | | | | | |



| Item | Specifications | Picture- للتوضيح | | | | | | | | | | | | |
|----------------------|-----------------------------------------------------------------------------------------------------------------------------------------------------------------------------------------------------------------------------------------------------------------------------------------------------------------------------------------------------------------------------------------------------------------------------------------------------------------------------------------------------------------------------------------------------------------------------------------------------------------------------------------------------------------------------------------------------------------------------------------------------------------------------------------------------------------------------------------------------------------------------------------------------------------------------------------------------------------------------------------------------------------------------------------------------------------------------------------------------------------------------------------------------------------------------------------------------------------------------------------------------------------------------------------------------------------------------------------------------------------------------------------------------------------------------------------------------------------------------------------------------------------------------------------------------------------------------------------------------------------------------------------------------------------------------------------------------------------------------------------------------------------------------------------------------------------------------------------------------------------------------------------------------------------------------------------------------------------------------------------------------------------------------------------------------------------------------------------------------------------------------------------------------------------------------------------------------------------------------------------------------------------------------------|-----------------------|-----------------------|-----------------------|-----------------------|-----------------------|-----------------------|-------------------|------------|-------------|-------------|-------------|-------------|------------------------------------------------------------------------------------------------------------------------------------------------------------------------------|
| Flexi worktop frames | <p>Flexi frames raise & lower worktops by up to 30cm. This can be done by simple winding handle or at the touch of a button.</p> <p>The design of the frames allows sinks & hobs to be inset into the worktop to provide an accessible work area set at the appropriate height.</p> <p>Flexi frames will suit any worktop length from 60 – 300cm and can be supplied as straight runs or as a corner arrangement to adjust both elevations simultaneously.</p> <p>Flexi Frames are ideal for:</p> <ul style="list-style-type: none"> • Social Housing with accessible kitchens for wheelchair users • Adaptations combined with rise & fall worktops • Student Accommodation in a fully inclusive kitchen • Rehab Centres with flexible solutions for disabled people • Food Technology with accessibility for a range of users <div data-bbox="337 888 938 1060"> <p>FlexiElectric standard frame for worktop 55-295cm</p> <p>FlexiElectric including worktop and fascia 60-300cm</p> <p>Standard Control Switch 3x6cm Delivered with the frame</p> </div> <table border="1" data-bbox="337 1066 938 1192"> <thead> <tr> <th>Models/Item</th> <th>MFBE-60/ MFBE-100</th> <th>MFBE-105/ MFBE-150</th> <th>MFBE-155/ MFBE-200</th> <th>MFBE-205/ MFBE-250</th> <th>MFBE-255/ MFBE-300</th> </tr> </thead> <tbody> <tr> <td>Length of worktop</td> <td>60 - 100cm</td> <td>105 - 150cm</td> <td>155 - 200cm</td> <td>205 - 250cm</td> <td>255 - 300cm</td> </tr> </tbody> </table> <p>Tips</p> <ul style="list-style-type: none"> - Allow a space of 3-5mms either side of the worktop. - An upstand fitted to the worktop prevents liquids flowing over the back edge. - Use fascia panels of 5-8cm at the front of the frame. - FlexiElectric Safety Strips should be fitted below all fascia panels. - Add Smart Box for each adjacent FlexiElectric. - The control unit must always be fitted to the underside of the worktop. - Large press pads are best for limited dexterity but the standard control is more discreet. - Max. load on the frame is 150kg evenly distributed over the entire frame. | Models/Item | MFBE-60/ MFBE-100 | MFBE-105/ MFBE-150 | MFBE-155/ MFBE-200 | MFBE-205/ MFBE-250 | MFBE-255/ MFBE-300 | Length of worktop | 60 - 100cm | 105 - 150cm | 155 - 200cm | 205 - 250cm | 255 - 300cm | <p>http://www.scanflex.co.uk/flexi-worktop-frames.html#prettyPhoto[iframes]/0/</p> |
| Models/Item | MFBE-60/ MFBE-100 | MFBE-105/ MFBE-150 | MFBE-155/ MFBE-200 | MFBE-205/ MFBE-250 | MFBE-255/ MFBE-300 | | | | | | | | | |
| Length of worktop | 60 - 100cm | 105 - 150cm | 155 - 200cm | 205 - 250cm | 255 - 300cm | | | | | | | | | |

جدول أسعار رقم (2)
العلاج الطبيعي

| Item# | Product name | QTY | Unit | Unit Price ILS | Total Price ILS |
|-------|--------------------------------------------------------------|------|------|----------------|-----------------|
| 1 | middelco MP 430 E Patient Bed سرير كهربائي للمساج | 6.00 | عدد | | |
| 2 | Bobath bed | 1.00 | عدد | | |
| 3 | Ultrasound unit ENRAF, Model: Enraf Sonopuls 190 | 1.00 | Each | | |
| 4 | Laser Therapy ENRAF, Model: Endolaser 422 | 1.00 | Each | | |
| 5 | Electrical Stimulation unit. Comprehensive unite ENRAF, Mode | 1.00 | Each | | |
| 6 | Infrared Lamp | 1.00 | عدد | | |
| 7 | X-RAY Viewer 1 Channel | 1.00 | عدد | | |
| 8 | Parafin Bath, 3 kg, Chaatanoga, USA | 2.00 | عدد | | |
| 9 | TNS 2 Channel | 4.00 | عدد | | |
| 10 | Hydrocollator ENRAF, Model: Packheter M2 | 1.00 | Each | | |
| 11 | Chilling unit for cryotherapy ENRAF, Model: C-5 | 1.00 | Each | | |
| 12 | Electrical traction back, neck with all accessory | 1.00 | Each | | |
| 13 | Shock Wave | 1.00 | Each | | |
| 14 | 12-channel ECG | 2.00 | عدد | | |
| 15 | Shoulder Wheel | 1.00 | عدد | | |
| 16 | Balance Board | 3.00 | Each | | |
| 17 | Parallel Bars | 1.00 | عدد | | |
| 18 | جهاز القشاش المشى (Treadmill) | 2.00 | Each | | |
| 19 | مجسم درج سندويش بلوط مع درابزين 80x15095 سم | 1.00 | Each | | |
| 20 | Therapy Mats | 6.00 | Each | | |
| 21 | Electrical Tilting Table | 1.00 | Each | | |
| 22 | Quadriceps Exerciser | 1.00 | Each | | |
| 23 | Wall Pulley with Full Standard Accessories | 1.00 | Each | | |
| 24 | Mobile Mirrors (4 castors) | 5.00 | Each | | |
| 25 | Thera-Band | 5.00 | لفة | | |
| 26 | Wooden Wall Ladder | 3.00 | عدد | | |
| 27 | Standard Accessories for Suspension Frame | 1.00 | Each | | |
| 28 | Rollers (one set) | 1.00 | Each | | |
| 29 | Paraffin Wax | 6.00 | عدد | | |
| 30 | Weights Set | 5.00 | Each | | |
| 31 | Ultra Sound Gel | 3.00 | عدد | | |
| 32 | درج سرير مرضى | 5.00 | عدد | | |
| 33 | Electronic Scale ميزان وزن الكتروني | 5.00 | عدد | | |
| 34 | Therapeutic balls (different sizes) | 6.00 | عدد | | |
| 35 | Dumbble | 1.00 | kg | | |
| 36 | جهاز الدراجة الهوائية الثابتة | 3.00 | Each | | |
| 37 | Walkers for adult | 2.00 | عدد | | |
| 38 | Standing Frame for Kids | 1.00 | Each | | |

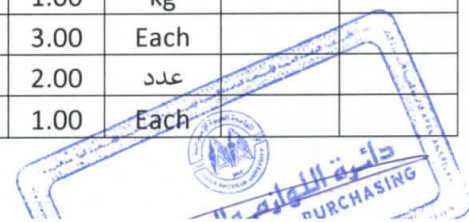

| Item# | Product name | QTY | Unit | Unit Price ILS | Total Price ILS |
|--------------|----------------------------------------------|-------|------|----------------|-----------------|
| 39 | Paraffin Oil (mineral oil) | 10.00 | لتر | | |
| 40 | Elbow craches for adult | 10.00 | عدد | | |
| 41 | Elbow craches for children | 10.00 | عدد | | |
| 42 | Wedges cushion | 5.00 | عدد | | |
| 43 | Massage Tools (set) | 2.00 | عدد | | |
| 44 | Walking ladder | 1.00 | عدد | | |
| 45 | Wheel chair كرسى عجالات طبي | 2.00 | عدد | | |
| 46 | منشر غسيل | 1.00 | عدد | | |
| 47 | Trangular | 3.00 | Each | | |
| 48 | PT Assessment | 6.00 | Kit | | |
| 49 | Rings | 1.00 | Kit | | |
| 50 | Traffic cones | 2.00 | Kit | | |
| 51 | Wooden ramp (crubs -ramp) | 1.00 | عدد | | |
| 52 | Hand exercise web (resitance ring) | 3.00 | عدد | | |
| 53 | Barrel roll (tumble form) | 1.00 | عدد | | |
| 54 | Massage vibrator | 4.00 | عدد | | |
| 55 | Half cylinder cushion | 2.00 | عدد | | |
| 56 | Balls | 4.00 | عدد | | |
| 57 | Airex non slip mat | 6.00 | عدد | | |
| 58 | Fillable strength training balls with handel | 6.00 | عدد | | |
| 59 | Multicoulor folding mat | 1.00 | عدد | | |
| 60 | Mobility exercises arc | 1.00 | عدد | | |
| 61 | Pronator -supinator tool for exercise | 1.00 | عدد | | |
| 62 | Pt-electrode | 6.00 | عدد | | |
| 63 | STEPPER | 3.00 | عدد | | |
| 64 | KINSO اللواصق الطبية | 5.00 | لفة | | |
| Total | | | | | |

- في حالة وجود استفسار يرجى تزويدنا بها من خلال البريد الالكتروني للرد عليها pnnp@aaup.edu
- تقبل عروض الاسعار حسب الوصف أعلاه أو ما يعادله



مواصفات العلاج الطبيعي

Item 1

Examination & treatments table for massage

- *Application : physiotherapy*
- *3 years warranty .*
- *2 section*
- *electric height-adjustable from 42 – 100*
- *lift up to 200 kg*
- *Continues adjustment up & down (electric) .*
- *Size L X W X H cm : 195 X 66 X 100*
- *Foam Thickness: 5cm*
- *Adjustable head section double gas struts, adjustable angle : +30° to -75°.*
- *Retractable castors 75mm .*
- *artificial leather upholstery , Steel White epoxy coated frame .*
- *Fire/stain/mildew/oil/water/wear resistant*
- *with paper roll holder .*
- *Kindly your offer will not be taken into our consideration if you don't fill below table.*

| Examination & treatments table for massage | Yes/No | Comment |
|------------------------------------------------------------------------------------|----------------------|----------------|
| <i>Manufacture</i> | <i>Manufacture</i> | |
| <i>Model</i> | <i>Model</i> | |
| <i>Origin</i> | <i>Origin</i> | |
| <i>Delivery time</i> | <i>Delivery time</i> | |
| <i>3 years warranty and 10 years availability for spare parts</i> | <i>Yes/No</i> | |
| <i>Application : physiotherapy</i> | <i>Yes/No</i> | |
| <i>2 section</i> | <i>Yes/No</i> | |
| <i>electric height-adjustable from 42 – 100 with hand control</i> | <i>Yes/No</i> | |
| <i>lift up to 200 kg</i> | <i>Yes/No</i> | |
| <i>Continues adjustment up & down (electric) .</i> | <i>Yes/No</i> | |
| <i>Size L X W X H cm : 195 X 66 X (42 – 100)</i> | <i>Yes/No</i> | |
| <i>Foam Thickness: 5cm</i> | <i>Yes/No</i> | |
| <i>Adjustable head section double gas struts, adjustable angle : +30° to -75°.</i> | <i>Yes/No</i> | |
| <i>Retractable castors 75mm .</i> | <i>Yes/No</i> | |
| <i>mildew/ Fire/stain/oil/water/wear resistant</i> | <i>Yes/No</i> | |
| <i>artificial leather upholstery , Steel White epoxy coated frame .</i> | <i>Yes/No</i> | |
| <i>Price include installation in site .</i> | <i>Yes/No</i> | |



صورة توضيحية

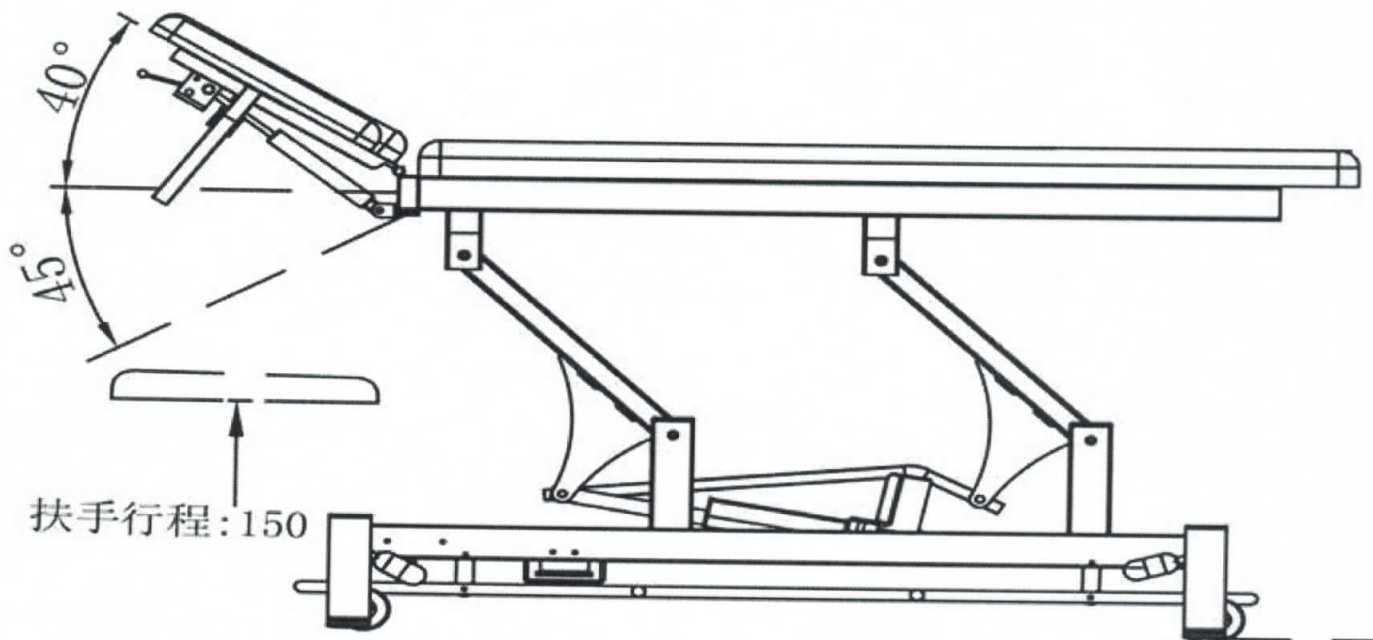
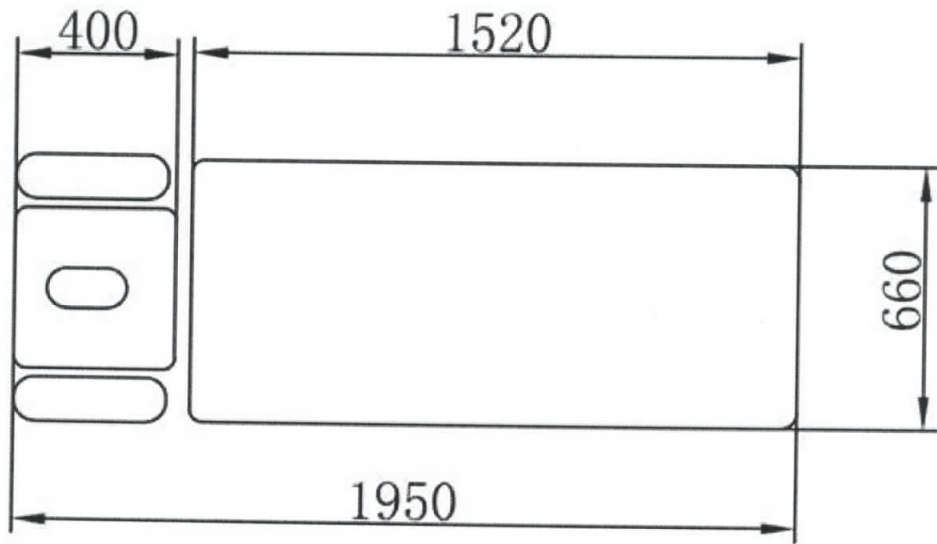

جامعة الازم والمشتريات
DEPARTMENT OF PURCHASING
DEPARTMENT

Item 2-A

Electric Bobath BED

- *Application : physiotherapy*
- *3 years warranty .*
- *1 section*
- *electric height-adjustable*
- *lift up to 200 kg*
- *Size L X W X H cm : 195 X 66 X 42-100*
- *Foam Thickness: 5cm*
- *Retractable castors 75mm .*
- *artificial leather upholstery , Steel White epoxy coated frame .*
- *Fire/stain/mildew/oil/water/wear resistant*
- *OPTINAL : SIDE RAIL .*
- *Kindly your offer will not be taken into our consideration if you don't fill below table.*

| • Electric Bobath BED | Yes/No | Comment |
|-------------------------------------------------------------------------|---------------|----------------|
| <i>Manufacture</i> | Manufacture | |
| <i>Model</i> | Model | |
| <i>Origin</i> | Origin | |
| <i>Delivery time</i> | Delivery time | |
| <i>3 years warranty and 10 years availability for spare parts</i> | Yes/No | |
| <i>Application : physiotherapy</i> | Yes/No | |
| <i>1 section</i> | Yes/No | |
| <i>electric height-adjustable hand control</i> | Yes/No | |
| <i>lift up to 200 kg</i> | Yes/No | |
| <i>Size L X W X H cm : 195 X 120 X (42 – 100)</i> | Yes/No | |
| <i>Foam Thickness: 5cm</i> | Yes/No | |
| <i>Retractable castors 75mm .</i> | Yes/No | |
| <i>mildew/ Fire/stain/oil/water/wear resistant</i> | Yes/No | |
| • <i>OPTINAL : SIDE RAIL</i> | | |
| <i>artificial leather upholstery , Steel White epoxy coated frame .</i> | Yes/No | |
| <i>Price include installation in site .</i> | Yes/No | |



Item 2-A

Hydraulic Bobath BED

- *Application : physiotherapy*
- *3 years warranty .*
- *1 section*
- *Hydraulic height-adjustable*
- *lift up to 200 kg .*
- *Size L X W X H cm : 195 X 66 X 42- 100*
- *Foam Thickness: 5cm*
- *Retractable castors 75mm .*
- *artificial leather upholstery , Steel White epoxy coated frame .*
- *Fire/stain/mildew/oil/water/wear resistant*
- *OPTINAL : SIDE RAIL .*
- *Kindly your offer will not be taken into our consideration if you don't fill below table.*

| Hydraulic Bobath BED | Yes/No | Comment |
|-------------------------------------------------------------------------|---------------|----------------|
| <i>Manufacture</i> | Manufacture | |
| <i>Model</i> | Model | |
| <i>Origin</i> | Origin | |
| <i>Delivery time</i> | Delivery time | |
| <i>3 years warranty and 10 years availability for spare parts</i> | Yes/No | |
| <i>Application : physiotherapy</i> | Yes/No | |
| <i>1 section</i> | Yes/No | |
| <i>Hydraulic height -adjustable hand control</i> | Yes/No | |
| <i>lift up to 200 kg</i> | Yes/No | |
| <i>Size L X W X H cm : 195 X 120 X (42 - 100)</i> | Yes/No | |
| <i>Foam Thickness: 5cm</i> | Yes/No | |
| <i>Retractable castors 75mm .</i> | Yes/No | |
| <i>mildew/ Fire/stain/oil/water/wear resistant</i> | Yes/No | |
| • <i>OPTINAL : SIDE RAIL</i> | | |
| <i>artificial leather upholstery , Steel White epoxy coated frame .</i> | Yes/No | |
| <i>Price include installation in site .</i> | Yes/No | |



Item3

Ultrasound Therapy

Application: : rehabilitation.

Origin : USA ,EURO .

System include:

Ultrasound with all stander accessories to be ready to use

Display: wide and good resolution screen.

With two channel independent

Pulse and continues therapy .Variable output : from 16 to 100 Hz.

Head warmer for probe . User friendly and simple.

Different clinical protocol.

1 & 3 MHz ultrasound frequencies pulse and continuous mode. Sound head coupling features with both visual & audio feedback. Head of ultrasound probe 5cm ².Option price: Cart . Probe : 5cm ².

السعر يشمل التدريب على الجهاز بالموقع بشكل كامل

❖ *Kindly your offer will not be taken into our consideration if you don't fill below table.*

| Ultrasound | Yes/No | Comment |
|-----------------------------------------------------------------|---------------|---------|
| Manufacture | Manufacture | |
| Model | Model | |
| Origin | Origin | |
| Delivery time | Delivery time | |
| 3 years warranty and 10 years availability for spare parts | Yes/No | |
| Applications : | Yes/No | |
| The system include : rehabilitation. | Yes/No | |
| Ultrasound with all stander accessories to be ready to use | Yes/No | |
| Display: wide and good resolution screen. | Yes/No | |
| Pulse and continues therapy . | Yes/No | |
| Variable output : from 16 to 100 Hz. | Yes/No | |
| Different clinical protocol. | Yes/No | |
| 1 & 3 MHz ultrasound frequencies pulse and continuous mode. | Yes/No | |
| Sound head coupling features with both visual & audio feedback. | Yes/No | |
| Head of ultrasound probe 5cm ² . Included in u.p | Yes/No | |
| Option price: | | |
| Cart . | Price | |
| Probe : 5cm ² . | Price | |
| Price include user and service manual | Price | |
| Price include installation and training in site . | Price | |



Item 4

Laser Therapy

Application: rehabilitation.

Origin: USA, EURO.

Wide and clear display .

Continuous and pulse operation.

Pre-programmed treatment protocols.

Display of energy in unit at joules or joules/cm² .

Real time feedback of energy delivered.

Probe included.

Power :220v.

* يرجى التكرم بتعبئة الجدول بالأسفل بالإضافة الى تقديم عرض تقني خاص بالشركة

| Laser Therapy | Yes/No | Comment |
|-----------------------------------------------------------------|---------------|---------|
| Manufacture | Manufacture | |
| Model | Model | |
| Origin | Origin | |
| Delivery time | Delivery time | |
| 3 years warranty and 10 years availability for spare parts | Yes/No | |
| Applications :physiotherapy. | Yes/No | |
| Wide and clear display . | Yes/No | |
| Continuous and pulse operation. | Yes/No | |
| Pre-programmed treatment protocols. | Yes/No | |
| Display of energy in unit at joules or joules/cm ² . | Yes/No | |
| Real time feedback of energy delivered. | Yes/No | |
| Probe included. | Yes/No | |
| Power :220v. | Yes/No | |
| Price include user and service manual | Yes/No | |
| Price include installation and training in site . | Yes/No | |



Item5

Electrical stimulation Therapy

Application: : rehabilitation.

Origin : USA ,EURO .

System include:

Electrical stimulation with all stander accessories to be ready to use
2 channel (independent)

Display: wide and good resolution screen.

User friendly and simple.

With stranded accessories and electrodes .

❖ *Kindly your offer will not be taken into our consideration if you don't fill below table.*

| Electrical stimulation Therapy | Yes/No | Comment |
|------------------------------------------------------------------------------------|---------------|----------------|
| Manufacture | Manufacture | |
| Model | Model | |
| Origin | Origin | |
| Delivery time | Delivery time | |
| 3years warranty and 10 years availability for spare parts | Yes/No | |
| The system include : rehabilitation. | Yes/No | |
| Electrical stimulation with all stander accessories to be ready to use | Yes/No | |
| 2 channel (independent) | Yes/No | |
| Display: wide and good resolution screen. | Yes/No | |
| User friendly and simple. | Yes/No | |
| With standred accessories and electrodes . | Yes/No | |
| Price include user and service manual | Price | |
| Price include installation and training in site . | | |
| Any update of Software will be free of change if needed after of end the warranty. | | |



Item 6

Infrared with ultraviolet

Application: rehabilitation.

Origin: USA, EURO.

Infrared with ultraviolet.

Adjustable arm and highest .

* يرجى التكرم بتعبئة الجدول بالأسفل بالإضافة الى تقديم عرض تقني خاص بالشركة

| Infrared ultraviolet | Yes/No | Comment |
|--------------------------------------------------------------|---------------|----------------|
| Manufacture | Manufacture | |
| Model | Model | |
| Origin | Origin | |
| Delivery time | Delivery time | |
| Two years warranty and 10 years availability for spare parts | Yes/No | |
| Applications : rehabilitation | Yes/No | |
| Infrared with ultraviolet . | Yes/No | |
| Adjustable arm and highest . | Yes/No | |
| Price include user and service manual | Yes/No | |
| Price include installation and training in site . | Yes/No | |



Item 8

Paraffin bath**Application: rehabilitation.****Origin: USA, EURO.**

- Volume : 10 L .
- Temperature range : 45 – 65 c .
- With safety thermostat .
- insulation to prevent heat loss

* يرجى التكرم بتعبئة الجدول بالأسفل بالإضافة الى تقديم عرض تقني خاص بالشركة

| Paraffin bath | Yes/No | Comment |
|--------------------------------------------------------------|---------------|---------|
| Manufacture | Manufacture | |
| Model | Model | |
| Origin | Origin | |
| Delivery time | Delivery time | |
| Two years warranty and 10 years availability for spare parts | Yes/No | |
| Applications : rehabilitation . | Yes/No | |
| Volume : 6 L . | Yes/No | |
| Temperature range : 45 – 65 c . | Yes/No | |
| With safety thermostat | Yes/No | |
| insulation to prevent heat loss | | |
| Price include user and service manual | Yes/No | |
| Price include installation and training in site . | Yes/No | |



Item 9

Tens**Application: rehabilitation.****Origin: USA, EURO.**

- Hand held .
- Two channel independent .
- Waveform: Asymmetric biphasic square pulse .
- Pulse freq : 2 -150 Hz adjustable .
- Pulse Width: 60-250 μ sec. adjustable .
- Pulse Amplitude: 0-80 mA each channel adjustable (500 ohm load).
- Clear and wide display .
- TENS can be used to treat most types of pain : chronic , acute , rheumatic , amputation ,
- Tens can used for most of position : neck , back , shoulder ,elbow , arm hand wrist , QUADRICEPS ,
plz mention all position if you have more .
- Complete with all accessories . . يرجى توضيح رقم الكتالوجي للقطع حتى يتم طلبها لاحقا .
- With electrodes , with lead wires , battery .

* يرجى التكرم بتعبئة الجدول بالأسفل بالإضافة الى تقديم عرض تقني خاص بالشركة

| Tens | Yes/No | Comment |
|--------------------------------------------------------------------------------------------------------------------------------------------------------|---------------|----------------|
| Manufacture | Manufacture | |
| Model | Model | |
| Origin | Origin | |
| Delivery time | Delivery time | |
| 3 years warranty and 10 years availability for spare parts | Yes/No | |
| Applications : rehabilitation. | Yes/No | |
| Hand held . | Yes/No | |
| Two channel independent . | Yes/No | |
| Waveform: Asymmetric biphasic square pulse . | Yes/No | |
| Pulse freq : 2 -150 Hz adjustable | Yes/No | |
| Pulse Width: 60-290 μ sec. adjustable . | Yes/No | |
| Pulse Amplitude: 0-80 mA each channel adjustable (500 ohm load). | Yes/No | |
| Clear and wide display . | Yes/No | |
| TENS can be used to treat most types of pain : chronic , acute , rheumatic , amputation , | Yes/No | |
| Tens can used for most of position : neck , back , shoulder ,elbow , arm hand wrist , QUADRICEPS , plz mention all position if you have more . | Yes/No | |
| Complete with all accessories . . يرجى توضيح رقم الكتالوجي للقطع حتى يتم طلبها لاحقا . | Yes/No | |
| With electrodes , with lead wires , battery . | Yes/No | |
| Price include user and service manual | Yes/No | |
| Price include installation and training in site . | Yes/No | |



Item 10

Hydrocollator**Application: rehabilitation.****Origin: USA, EURO.**

- Volume : 50 L .
- Temperature range : 71 – 75 C .
- Thermal Cut-Out Temp : 80 - 85 C .
- Heat up Time (to 71°C) : 8 hours/day .
- fiberglass insulation to prevent heat loss.
- high grade stainless steel .
- Simple to fill with water(No plumbing required) .
- With water drain for easy cleaning .
- Included in your unit price set of (3 HotPac and Foam Filled Terry) .
- **Optional price and cat No:**
heater .

* يرجى التكرم بتعبئة الجدول بالأسفل بالإضافة الى تقديم عرض تقني خاص بالشركة

| Hydrocollator | Yes/No | Comment |
|----------------------------------------------------------------------------|---------------|----------------|
| Manufacture | Manufacture | |
| Model | Model | |
| Origin | Origin | |
| Delivery time | Delivery time | |
| Two years warranty and 10 years availability for spare parts | Yes/No | |
| Applications : rehabilitation. | Yes/No | |
| Volume : 50 L . | Yes/No | |
| Temperature range : 71 – 75 C . | Yes/No | |
| Thermal Cut-Out Temp : 80 - 85 C . | Yes/No | |
| Heat up Time (to 71°C) : 8 hours/day . | Yes/No | |
| fiberglass insulation to prevent heat loss. | Yes/No | |
| high grade stainless steel . | Yes/No | |
| With water drain for easy cleaning . | Yes/No | |
| Your Price included with U.P : set of (3 HotPac and Foam Filled Terry) . | Yes/No | |
| Simple to fill with water (No plumbing required) . | Yes/No | |
| Optional (Price & cat No): | | |
| Price include user and service manual | Yes/No | |
| Price include installation and training in site . | Yes/No | |



Item 11

Chilling unit for cryotherapy**Application: rehabilitation.****Origin: USA, EURO.**

- Volume : 50 L .
- Temperature range : - 10 to - 5 C .
- Type of Refrigerant : R-134A
- fiberglass insulation to prevent heat loss.
- high grade stainless steel .
- Simple to fill with water(No plumbing required) .
- With water drain for easy cleaning .
- Your Price included with U.P : Set from (Blue Vinyl ColPac (Standard Size 28 cm x 36 cm , Neck contour 58 cm , 8 cm x 28 cm ,Quarter Size 14 cm x 19 cm) .

* يرجى التكرم بتعبئة الجدول بالأسفل بالإضافة الى تقديم عرض تقني خاص بالشركة

| Chilling unit for cryotherapy | Yes/No | Comment |
|--------------------------------------------------------------------------------------------------------------------------------------------------------------|---------------|----------------|
| Manufacture | Manufacture | |
| Model | Model | |
| Origin | Origin | |
| Delivery time | Delivery time | |
| Two years warranty and 10 years availability for spare parts | Yes/No | |
| Applications : rehabilitation . | Yes/No | |
| Volume : 50 L . | Yes/No | |
| Temperature range : - 10 to - 5 C . | Yes/No | |
| Type of Refrigerant : R-134A | Yes/No | |
| fiberglass insulation to prevent heat loss. | Yes/No | |
| high grade stainless steel . | Yes/No | |
| Simple to fill with water(No plumbing required) . | Yes/No | |
| With water drain for easy cleaning . | Yes/No | |
| Your Price included with U.P : Set from (Blue Vinyl ColPac (Standard Size 28 cm x 36 cm , Neck contour 58 cm , 8 cm x 28 cm ,Quarter Size 14 cm x 19 cm) . | Yes/No | |
| Price include user and service manual | Yes/No | |
| Price include installation and training in site . | Yes/No | |



Item 12

Traction machine**Application: rehabilitation.****Origin: USA, EURO.**

- For lumbar and cervical.
- User defined rest , treat time , hold .
- Real time digital treatment tracking ..
- Therapy : continuous , intermittent , harmonized , progressive .
- Traction force : 0- 90 kg .
- Force time : / rest time : up to 98s.
- Treat time : 0 to 90 min .
- Safety : audible signal (patient interrupt switch activated , end of treatment)
- With all accessories : cervical traction attachment , pelvic attachment , knee bolsters , Flexion Stools , traction cord with metal fitting , patient interrupt switch , cervical harness separated bar , include in main price .
- **Optional price :**
Examination bed for retraction

* يرجى التكرم بتعبئة الجدول بالأسفل بالإضافة الى تقديم عرض تقني خاص بالشركة

| Traction machine | Yes/No | Comment |
|------------------------------------------------------------------------------------------------------------------------------------------------------------------------------------------------------------------------------------------|---------------|----------------|
| Manufacture | Manufacture | |
| Model | Model | |
| Origin | Origin | |
| Delivery time | Delivery time | |
| 3 years warranty and 10 years availability for spare parts | Yes/No | |
| Applications : rehabilitation . | Yes/No | |
| For lumbar and cervical. | Yes/No | |
| User friendly | Yes/No | |
| User defined rest , treat time , hold . | Yes/No | |
| Real time digital treatment tracking .. | Yes/No | |
| Therapy : continuous , intermittent , harmonized , progressive . | Yes/No | |
| Traction force : 0- 90 kg . | Yes/No | |
| Force time : / rest time : up to 98s. | Yes/No | |
| Treat time : 0 to 90 min . | Yes/No | |
| Safety : audible signal (patient interrupt switch activated ,end of treatment) | Yes/No | |
| With all accessories : cervical traction attachment , pelvic attachment , knee bolsters , Flexion Stools , traction cord with metal fitting , patient interrupt switch , cervical harness separated bar , include in main price . | Yes/No | |
| Optional price : | | |
| Manufacture of Examination bed with 2 years warranty | Manufacture | |
| Price for bed | Price | |
| model | Model , | |
| Origin | Origin | |
| Examination bed for retraction | Yes/No | |
| Price include user and service manual | Yes/No | |
| Price include installation and training in site . | Yes/No | |



Item 13

(Diathermy) Shortwave therapy**Application: rehabilitation.****Origin: USA, EURO.**

- Microprocessor control.
- Continuous and pulse mode.
- Capacity and indicative electrode available.
- With timer: automatic ends therapy after preset time has elapsed.
- Output power in continuous mode: 400 W.
- Output power in pulse mode: 1000 W .
- Complete system with all stander accessories and set of different filed applicator .
- **Optional price :**
Different filed applicator

* يرجى التكرم بتعبئة الجدول بالأسفل بالإضافة الى تقديم عرض تقني خاص بالشركة

| Shortwave therapy | Yes/No | Comment |
|-------------------------------------------------------------------------------------------|---------------|----------------|
| Manufacture | Manufacture | |
| Model | Model | |
| Origin | Origin | |
| Delivery time | Delivery time | |
| 3 years warranty and 10 years availability for spare parts | Yes/No | |
| Applications : rehabilitation. | Yes/No | |
| Microprocessor control. | Yes/No | |
| Continuous and pulse mode. | Yes/No | |
| Capacity and indicative electrode available. | Yes/No | |
| With timer: automatic ends therapy after preset time has elapsed. | Yes/No | |
| Output power in continuous mode: 400 W. | Yes/No | |
| Output power in pulse mode: 1000 W . | Yes/No | |
| Complete system with all stander accessories and set of different filed applicator | Yes/No | |
| Optional price : | | |
| Different filed applicator | price | |
| Price include user and service manual | Yes/No | |
| Price include installation and training in site . | Yes/No | |



Item 14

12-channel ECG

- Graphic Display and Diagnostics ECG Recorder
- Clear display
- 12-channel ECG for printing and recording
- Automatic, manual mode and long ECG recording
- Real-time and synchronized mode
- 10 user-defined profiles
- Indication of contact of each electrode
- Pacemaker detection and Defibrillation protection
- With electrodes and roll paper dust cover gel and all accessories to work completely
optional :
- Trolley

| 12-channel ECG | Yes/No | Comment |
|----------------------------------------------------------------------------------|-----------------|---------|
| Manufacture | Manufactur e | |
| Model | Model | |
| Origin | Origin | |
| Delivery time | Delivery | |
| 3 years for motor and machine warranty and 10 years availability for spare parts | Yes/No | |
| • Graphic Display and Diagnostics ECG Recorder | Yes/No | |
| • Clear display | Yes/No | |
| • 12-channel ECG for printing and recording | Yes/No | |
| • Automatic, manual mode and long ECG recording | Yes/No | |
| • Real-time and synchronized mode | Yes/No | |
| • 10 user-defined profiles | Yes/No | |
| • Indication of contact of each electrode | Yes/No | |
| <i>optional :</i> | | |
| • Trolley | | |
| Price include user and service manual , | Yes/No | |
| Price include installation and training in site . | Yes/No | |



Item 17
Platform Mounted Parallel Bars

Application: physiotherapy.
Origin: USA ,EURO .

- hardwood plywood base with ultra-durable
- Parallel bars mounted 1 ½" diameter stainless steel handrails for easy use and durability
- Safety tread at both ends of the platform
- Heavy duty, square, telescoping, steel uprights
- Easy height changes with spring-loaded plungers and numbered height indicator strips
- Second height knob removes side to side play
- End bumpers on all handrails
- load capacity: 145 kg.

❖ *Kindly your offer will not be taken into our consideration if you don't fill below table.*

| Platform Mounted Parallel Bars | Yes/No | Comment |
|-------------------------------------------------------------------------------------------|---------------|---------|
| Manufacture | Manufacture | |
| Model | Model | |
| Origin | Origin | |
| Delivery time | Delivery time | |
| Two years warranty and 10 years availability for spare parts | Yes/No | |
| hardwood plywood base with ultra-durable | Yes/No | |
| Parallel bars mounted 1 ½" diameter stainless steel handrails for easy use and durability | Yes/No | |
| Safety tread at both ends of the platform | Yes/No | |
| Heavy duty, square, telescoping, steel uprights | Yes/No | |
| Easy height changes with spring-loaded plungers and numbered height indicator strips | | |
| Second height knob removes side to side play | | |
| End bumpers on all handrails | | |
| load capacity: 145 kg. | | |
| Price include installation and training in site. | | |

* تلتنزم الشركة بتقديم كافة ملحقات والاضافات اللازمة لعمل الجهاز أو تسعيرها بشكل واضح وابداء اية ملاحظات ضرورية للجهاز أو المكان قبل التوريد



Item 18 –A

Treadmill

Application: physiotherapy.

Origin: USA, EURO.

- waking deck: 200cm L x 120cm D.
- user weight up to: 180 kg.
- wide and clear display.
- speed incumbent: 0.3 Km/h.
- direction of walking: forward and reverse.
- display: speed, time, distance, heart rate, calories evaluation and pace.
- Emergency stop.
- with side hand rear.
- incline 0 - 30 %.
- motor: 4 HP/Power: 230 V.

Option:

- Anti-fall Support, Under arm support, Harness.

يرجى التكرم بتعبئة الجدول بالأسفل بالإضافة الى تقديم عرض تقني خاص بالشركة

| Treadmill | Yes/No | Comment |
|---------------------------------------------------------------------------|---------------|---------|
| Manufacture | Manufacture | |
| Model | Model | |
| Origin | Origin | |
| Delivery time | Delivery time | |
| Two years warranty and 10 years availability for spare parts | Yes/No | |
| waking deck: 200cm L x 120cm D. | Yes/No | |
| user weight up to: 180 kg. | Yes/No | |
| wide and clear display. | Yes/No | |
| speed incumbent: 0.3 Km/h. | Yes/No | |
| direction of walking : forward and reverse. | Yes/No | |
| display: speed, time, distance, heart rate, calories evaluation and pace. | Yes/No | |
| emergency stop. | Yes/No | |
| with side hand rear. | Yes/No | |
| incline 0 - 30 %. | Yes/No | |
| motor: 4 HP. | Yes/No | |
| Power: 230 V. | Yes/No | |
| Option: | | |
| Anti-fall Support. | Price | |
| Under arm support. | Price | |
| Harness. | Price | |
| Price include user and service manual | Yes/No | |
| Price include installation and training in site . | Yes/No | |

* تلتزم الشركة بتقديم كافة ملحقات والاضافات الازمة لعمل الجهاز أو تسعيرها بشكل واضح وابداء اية ملاحظات ضرورية للجهاز أو المكان قبل التوريد



Item 18 –B Gait for Pediatric

Application: physiotherapy.

Origin: USA, EURO.

- For pediatric
- Max user Weight up to : 45 KG
- adjustable for the user's height or activity to enable best practice for gait.
- balance, play activities, and activities of daily living.
- Support in standing, seated, or quadruped.
- use over a treadmill, overground, or engage with balance equipment, toys, and other equipment
- with Harness and castors .
- Parallel Grab Bar
- plz quote all accessories separately

* تلتزم الشركة بتقديم كافة ملحقات والاضافات اللازمة لعمل الجهاز أو تسعيرها بشكل واضح وابداء اية ملاحظات ضرورية للجهاز أو المكان قبل التوريد

| Gait for Pediatric | Yes/No | Comment |
|------------------------------------------------------------|---------------|---------|
| Manufacture | Manufacture | |
| Model | Model | |
| Origin | Origin | |
| Delivery time | Delivery time | |
| 3 years warranty and 10 years availability for spare parts | Yes/No | |
| • For pediatric | Yes/No | |
| • Max user Weight up to : 45 KG | Yes/No | |
| • adjustable for the user's height or activity to | Yes/No | |
| • balance, play activities, and activities of daily | Yes/No | |
| • Support in standing, seated, or quadruped. | Yes/No | |
| • use over a treadmill, overground, or engage with | Yes/No | |
| • with Harness and castors . | Yes/No | |
| • plz quote all accessories separately | Yes/No | |
| • Parallel Grab Bar | Price | |
| Price include user and service manual | Yes/No | |
| Price include installation and training in site . | Yes/No | |



Item 21

Electrical Tillable Table**Application: physiotherapy.**

Origin: USA, EURO.

- Warranty: 3 years for table and motor.
- 2 section.
- Electric height and tilt adjustment
- Able to lift and tilt up to 175kg.
- Dimensions: 190 L x 70 W
- Suitable for children
- Battery back up in the event of power failure is available.
- Tilt angle from horizontal to 90°
- Patient handles and one set of harnesses.
- Fully washable/ fire retardant
- Heavy-duty braked rubber castors , large wheel for safe movement .

* يرجى التكرم بتعبئة الجدول بالأسفل بالإضافة الى تقديم عرض تقني خاص بالشركة

| Electrical Tillable table | Yes/No | Comment |
|---------------------------------------------------------------------------------|---------------|---------|
| Manufacture | Manufacture | |
| Model | Model | |
| Origin | Origin | |
| Delivery time | Delivery time | |
| Warranty: 3 years for table and motor and 10 years availability for spare parts | Yes/No | |
| 2 section. Electric height and tilt adjustment | Yes/No | |
| Able to lift and tilt up to 175kg. | Yes/No | |
| Suitable for children | Yes/No | |
| Battery back up in the event of power failure is available. | Yes/No | |
| Tilt angle from horizontal to 90° | Yes/No | |
| Patient handles and one set of harnesses. | Yes/No | |
| Fully washable/ fire retardant | Yes/No | |
| Heavy-duty braked rubber castors , large wheel for safe movement . | Yes/No | |
| Price include user and service manual | Yes/No | |
| Price include installation and training in site . | Yes/No | |



Item 22

Quadriceps exercise bench**Application: physiotherapy.****Origin: USA, EURO.**

- Warranty: 3 years
- multipurpose chair for muscle training and for upper- and lower limb rehabilitation
- swinging arm can be used on both sides
- resistance is obtained by applying the weights: 4 x 2 kg, 1 x 1 kg, 1 x 0,5 kg
- Electric height and tilt adjustment
- load movement range and application point can all be independently adjusted.
- backrest can be horizontally adjusted up to 90° by means of a gas spring
- in order to allow leg exercise in prone position, the backrest can be pulled down upon 180°
- thighs can be fixed by a upholstered support system and feet can be fastened by means of straps

* يرجى التكرم بتعبئة الجدول بالأسفل بالإضافة الى تقديم عرض تقني خاص بالشركة

| Quadriceps exercise bench | Yes/No | Comment |
|---------------------------------------------------------------------------------------------------|---------------|---------|
| Manufacture | Manufacture | |
| Model | Model | |
| Origin | Origin | |
| Delivery time | Delivery time | |
| Warranty: 3 years for table and 10 years availability for spare parts | Yes/No | |
| • multipurpose chair for muscle training and for upper- and lower limb rehabilitation | Yes/No | |
| • swinging arm can be used on both sides | Yes/No | |
| • resistance is obtained by applying the weights: 4 x 2 kg, 1 x 1 kg, 1 x 0,5 kg | Yes/No | |
| • Electric height and tilt adjustment | Yes/No | |
| • load movement range and application point can all be independently adjusted. | Yes/No | |
| • backrest can be horizontally adjusted up to 90° by means of a gas spring | Yes/No | |
| • in order to allow leg exercise in prone position, the backrest can be pulled down upon 180° | Yes/No | |
| • thighs can be fixed by a upholstered support system and feet can be fastened by means of straps | Yes/No | |
| Price include user and service manual | Yes/No | |
| Price include installation and training in site . | Yes/No | |



Item 23

Wall Pulley

Application: physiotherapy.

Origin: USA, EURO.

- **SPACE SAVER .**
- **DUAL PULLEY SYSTEMS:** With 16 adjustment positions to allow the user to perform a wide range of bilateral and unilateral exercises.
- **DOUBLE BAR TRACK:** Provides stability and allows the plate loaded carriage system to glide smoothly along the tracks, supplying the perfect amount of resistance.
- **WALL MOUNT:**
- **INCLUDES STRAP HANDLES:** Two, single strap handles are included in the purchase and can be adjusted to 5 positions.
- **HOLDS STANDARD PLATES:**
- Includes a bracket to create a single anchor point for attachments. The 80" tall and must be mounted to the wall. The ratio is approximately 1 to 1. Max weight load of 90 kg.

| Wall Pulley | Yes/No | Comment |
|----------------------------------------------------------------------------------------------------------------------------------------------------------------------------------|---------------|---------|
| Manufacture | Manufacture | |
| Model | Model | |
| Origin | Origin | |
| Delivery time | Delivery time | |
| Warranty: 3 years for table and 10 years availability for spare parts | Yes/No | |
| • SPACE SAVER . | Yes/No | |
| • DUAL PULLEY SYSTEMS: With 16 adjustment positions to allow the user to perform a wide range of bilateral and unilateral exercises. | Yes/No | |
| • DOUBLE BAR TRACK: Provides stability and allows the plate loaded carriage system to glide smoothly along the tracks, supplying the perfect amount of resistance. | Yes/No | |
| • WALL MOUNT: | Yes/No | |
| • INCLUDES STRAP HANDLES: Two, single strap handles are included in the purchase and can be adjusted to 5 positions. | Yes/No | |
| • HOLDS STANDARD PLATES: | Yes/No | |
| • Includes a bracket to create a single anchor point for attachments. The 80" tall and must be mounted to the wall. The ratio is approximately 1 to 1. Max weight load of 90 kg. | Yes/No | |
| | Yes/No | |
| Price include user and service manual | Yes/No | |
| Price include installation and training in site . | Yes/No | |





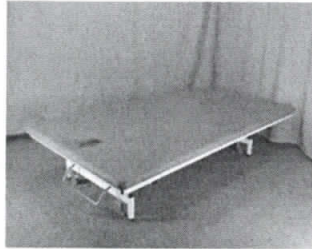

مواصفات الطليبة العلاج الطبيعي

- يشترط بجميع الأجهزة والأدوات والمستهلكات ان تكون المواد المستخدمة والمصنعة بها آمنة عند الاستخدام مع المرضى ولايوجد بها حواف او ضعف تسبب في أي ملاحظات ضرر
- ويشترط التركيب والتدريب لجميع الأجهزة عند التسليم .
- يجب تعبئة المرفقات (جدول المطابقة) بشكل واضح عند التسعير .
- يجب ان تكون الأجهزة مكفولة حسب المطلوب او سنه للمواد والأجهزة الغير مذكورة .

| ITEM | DESCRIPTION- الصورة للتوضيح | | | | | | | | | | | | | | |
|------------------------------------------------------------------------------------|-----------------------------------------------------------------------------------------------------------------------------------------------------------------------------------------------------------------------------------------------------------------------------------------------------------------------------------------------------------------------------------------------------------------------------------------------------------------------------------------------------------------------------------------------------------------------------------------------------------------------------------------------------------------------------------------------------------------------------------------------------------------------------------------------------------------|----|-------|--------|---------------|-----------------------------------------------------------|--------------------------------------|------------------------------------------------------------------------|---------------------------|-------------------------------------------|---------------------------|--------------------------------------------|---------------------------------------|---------------------------------------------------|------------------------------------------------------------------------------------|
| سرير كهربائي للمساج |  | | | | | | | | | | | | | | |
| Bobath bed | <p>Electrical height adjustment with footswitch and central locking wheels</p>  | | | | | | | | | | | | | | |
| Ultrasound | <table border="1"> <tr><td>re</td></tr> <tr><td>Model</td></tr> <tr><td>Origin</td></tr> <tr><td>Delivery time</td></tr> <tr><td>3years warranty and 10 years availability for spare parts</td></tr> <tr><td>The system include : rehabilitation.</td></tr> <tr><td>Electrical stimulation with all stander accessories to be ready to use</td></tr> <tr><td>2 channel (independent)</td></tr> <tr><td>Display: wide and good resolution screen.</td></tr> <tr><td>User friendly and simple.</td></tr> <tr><td>With standred accessories and electrodes .</td></tr> <tr><td>Price include user and service manual</td></tr> <tr><td>Price include installation and training in site .</td></tr> <tr><td>Any update of Software will be free of change if needed after of end the warranty.</td></tr> </table> | re | Model | Origin | Delivery time | 3years warranty and 10 years availability for spare parts | The system include : rehabilitation. | Electrical stimulation with all stander accessories to be ready to use | 2 channel (independent) | Display: wide and good resolution screen. | User friendly and simple. | With standred accessories and electrodes . | Price include user and service manual | Price include installation and training in site . | Any update of Software will be free of change if needed after of end the warranty. |
| re | | | | | | | | | | | | | | | |
| Model | | | | | | | | | | | | | | | |
| Origin | | | | | | | | | | | | | | | |
| Delivery time | | | | | | | | | | | | | | | |
| 3years warranty and 10 years availability for spare parts | | | | | | | | | | | | | | | |
| The system include : rehabilitation. | | | | | | | | | | | | | | | |
| Electrical stimulation with all stander accessories to be ready to use | | | | | | | | | | | | | | | |
| 2 channel (independent) | | | | | | | | | | | | | | | |
| Display: wide and good resolution screen. | | | | | | | | | | | | | | | |
| User friendly and simple. | | | | | | | | | | | | | | | |
| With standred accessories and electrodes . | | | | | | | | | | | | | | | |
| Price include user and service manual | | | | | | | | | | | | | | | |
| Price include installation and training in site . | | | | | | | | | | | | | | | |
| Any update of Software will be free of change if needed after of end the warranty. | | | | | | | | | | | | | | | |



| ITEM | DESCRIPTION- الصورة للتوضيح | |
|-----------------------------|---------------------------------------------------------------------------------------------------------------------------------------------------------------------------------------------------------------------------------------------------------------------------------------------------------------------------------------------------------------------------------------------------------------------------------------------------------------------------------------------------------------------------------------------------------------------------------------------------------------------------------------------------------------------------------------------------------------------------------------------------------------------------------------------------------------------------------------------------------------------------------------------------------------------------------------------------------------------------------------------------------------------------------------------------------------------------------------------------------------------------------------------------------------------------------------------------------------------------------------------------------------------------------------------------------------------------------------------------------------------------------------------------------------------------------------------------------------------------------------------------------------------------------------------------------------------------------------------------------------------------------------------------------------------------------------------------------------------------------------------------------------------------------------------------------------------------------------------------------------------------------------------------------------------------------------------------------------------------------------------------------------------------------------------------------------------------------------------------------------------------------------------------------------------------------------------------------------------------------------------------------------------------------------------------------------------------------------------------------------------------------------------------------------------------------------------------------------------------------------------------------------------------------------------------------------------------------------------------------------------------------------------------------------------------------------------------------------------------------------------------------------------------------------------------------------------------------------------------------------------------------------------------------------------------------------------------------------------------------------------------------------------------------------------------------------------------------------------------------------------------------------------------------------------------------------------------------------------------------------------------------------------------------------------------------------------------------------------------------------------------------------------------------------------------------------------------------|--|
| |  | |
| Laser |  <p>ENDOLASER 422</p> <p>The Endolaser 422 is an advanced and effective laser system for the treatment of various conditions, including:</p> <ul style="list-style-type: none"> • Pain relief • Muscle relaxation • Anti-inflammatory effects • Wound healing • Hair removal • Skin rejuvenation <p>It is a portable and easy-to-use device, ideal for use in a wide range of settings. The device is controlled by a handpiece, which is held against the skin. The laser energy is delivered through the handpiece, providing targeted treatment to the affected area. The device is also equipped with a built-in timer and a power indicator, ensuring precise and safe treatment.</p> <p>Applications:</p> <ul style="list-style-type: none"> • Neck and shoulder pain • Back pain • Knee pain • Tennis elbow • Carpal tunnel syndrome • Arthritis • Osteoarthritis • Rheumatoid arthritis • Gout • Psoriasis • Eczema • Acne • Hair removal • Skin rejuvenation <p>Contraindications:</p> <ul style="list-style-type: none"> • Pregnancy • Breastfeeding • Active cancer • Active infection • Active skin disease • Active eye disease • Active heart disease • Active lung disease • Active kidney disease • Active liver disease • Active thyroid disease • Active diabetes • Active hypertension • Active hypotension • Active asthma • Active epilepsy • Active mental illness • Active drug or alcohol abuse • Active use of photosensitizing drugs • Active use of tetracycline antibiotics • Active use of retinoids • Active use of isotretinoin • Active use of fluoroquinolone antibiotics • Active use of sulfonamide antibiotics • Active use of trimethoprim-sulfamethoxazole • Active use of rifampin • Active use of rifabutin • Active use of rifapentine • Active use of bedaquiline • Active use of delamanid • Active use of clazacrine • Active use of oprelvekin • Active use of pegfilgrastim • Active use of filgrastim • Active use of sargramostim • Active use of interferon-α • Active use of interferon-β • Active use of interferon-γ • Active use of interferon-λ • Active use of interferon-τ • Active use of interferon-θ • Active use of interferon-ι • Active use of interferon-κ • Active use of interferon-μ • Active use of interferon-ν • Active use of interferon-ξ • Active use of interferon-ο • Active use of interferon-π • Active use of interferon-ρ • Active use of interferon-σ • Active use of interferon-τ • Active use of interferon-υ • Active use of interferon-φ • Active use of interferon-χ • Active use of interferon-ψ • Active use of interferon-ω | |
| Electrical Stimulation unit |  | |
| Infrared Lamp | <p>Application: rehabilitation.. Infrared with ultraviolet. Adjustable arm and highest .</p>  <p>With Chinese-made 275W bulb</p> | |
| X-RAY Viewer 1 Channel | <p>TECHNICAL CHARACTERISTICS - X-RAY VIEWERS - X-Ray Wall mounted viewer, one screen - Voltage 110v and 60Hz (OPTIONAL: BRITISH PLUG) - Voltage 110v and</p> | |



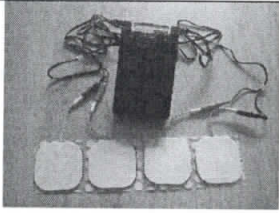



| ITEM | DESCRIPTION- الصورة للتوضيح |
|--------------------|-----------------------------------------------------------------------------------------------------------------------------------------------------------------------------------------------------------------------------------------------------------------------------------------------------------------------------------------------------------------------------------------------------------------------------------------------------------------------------------------------------------------------------------------------------------------------------------------------------------------------------------------------------------------------------------------------------------------------------------------------------------------------------------------------------------------------------------------------------------------------------------------------------------------------------------------------------------|
| |  |
| Parafin Bath, 3 kg | <p>Application: rehabilitation.</p> <p>Volume : 10 L .</p> <p>Temperature range : 45 – 65 c .</p> <p>With safety thermostat .</p> <p>insulation to prevent heat loss</p> |
| TNS 2 Channel |  <ul style="list-style-type: none"> • Hand-held design, small, lightweight and portable • Dual channel: suitable for 2 people or 2 different target points • TENS drug-free treatment: safe pain relief, nerve muscle stimulation, promote blood circulation and relieve fatigue • Large LED display screen: convenient control, clear display, simple operation • Voice function: convenient for elderly and disabled people to operate • Long performance: a fully charged battery lasts for 40 hours. • 6 modes: Tuina, tapping, vibration, Chinese needle, cupping and scraping to meet your massage needs • 11 pulse intensity classes: can be chosen according to your usage needs • Custom supported: Size and appearance can be customized according to your requirements |
| Hydrocollator | <ul style="list-style-type: none"> • Volume: 50 L. • Temperature range: 71– 75 C. • Thermal Cut-Out Temp: 80 - 85 C. • Heat up Time (to 71°C): 8 hours/day. • fiberglass insulation to prevent heat loss. • high grade stainless steel. • Simple to fill with water (No plumbing required). |

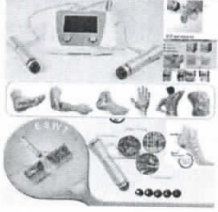

| ITEM | DESCRIPTION- الصورة للتوضيح |
|---------------------------------------------------|-----------------------------------------------------------------------------------------------------------------------------------------------------------------------------------------------------------------------------------------------------------------------------------------------------------------------------------------------------------------------------------------------------------------------------------------------------------------------------------------------------------------------------|
| | <ul style="list-style-type: none"> · With water drain for easy cleaning. · Included in your unit price set of (3 HotPac and Foam Filled Terry). · Optional price and cat No: heater. |
| Chilling unit for cryotherapy | <p>Status: Open</p> <p>Item type: Complete System</p> <p>Category: Physiotherapy/Physical Medicine</p> <p>Device: Cold Therapy System</p> <p>Manufacturer: -----</p> <p>Model: Chilling Unit C-6</p> <p>Condition: Never used</p> <p>Year manufactured:</p> <p>Location:</p> <p>Availability:</p> <p>Quantity:</p>  |
| Electrical traction back, neck with all accessory | <p>Application: rehabilitation.</p> <ul style="list-style-type: none"> • For lumbar and cervical. • User defined rest , treat time , hold . • Real time digital treatment tracking .. • Therapy : continuous , intermittent , harmonized , progressive • Traction force : 0- 90 kg . • Force time : / rest time : up to 98s. • Treat time : 0 to 90 min . • Safety : audible signal (patient interrupt switch activated , end of treatment) |







| ITEM | DESCRIPTION- الصورة للتوضيح |
|----------------|--------------------------------------------------------------------------------------------------------------------------------------------------------------------------------------------------------------------------------------------------------------------------------------------------------------------------------------------------------------------------------------------------------------------------------------------------------------------------------------------------------------------------|
| | <ul style="list-style-type: none"> • With all accessories : cervical traction attachment , pelvic attachment , knee bolsters , Flexion Stools , traction cord with metal fitting , patient interrupt switch , cervical harness separated bar , include in main price . • Optinal price : <p>Examination bed for retraction</p>  |
| Shock Wave |  <ul style="list-style-type: none"> <input type="checkbox"/> Product name ESWT Physiotherapy Shock <input type="checkbox"/> - shockwave Type Extracorporeal Shockwave <input type="checkbox"/> - shockwave Feature Smallest shock wave machi <input type="checkbox"/> - Shokcwave package Aluminium suitcase <input type="checkbox"/> - Power Levels / Energ 10 to 190mJ adjustable |
| EMG |  |
| Shoulder Wheel | <p>WALL SHOULDER WHEEL Shoulder and elbow rehabilitation instrument. The wheel is adjustable in height and wall-mountable. Powder-coated steel structure with chrome-plated sliding part. Resistance mechanism for effort adjustment. TECHNICAL SPECIFICATIONS Height: 160 cm Width: 110 cm Depth: 30 cm</p>  |
| Balance Board |  <p>At 17.5" x 13.5" x 3" in size, our lightweight balance exerciser / fit board can be used at therapy or training at home, the gym, or while traveling. A perfect standing desk accessory</p> |
| Parallel Bars | Application: physiotherapy. |



| ITEM | DESCRIPTION- الصورة للتوضيح |
|--------------------------------------------------------------------|------------------------------------------------------------------------------------------------------------------------------------------------------------------------------------------------------------------------------------------------------------------------------------------------------------------------------------------------------------------------------------------------------------------------------------------------------------------------------------------------------------------------------------------------------------------------------------------------------|
| | <p>hardwood plywood base with ultra-durable used to help teach children with mobility problems how to be better bear weight on legs stretch lower limbs and relax the hips and better walking and balancing .</p> <p>Parallel bars mounted stainless steel handrails for easy use and durability</p> <p>Safety tread at both ends of the platform</p> <p>Heavy duty, square, telescoping, steel uprights</p> <p>Easy height changes with spring-loaded plungers and numbered height indicator strips</p> <p>Second height knob removes side to side play</p> <p>End bumpers on all handrails</p> |
| <p>Body support Treadmill For pediatric and adults</p> | <div data-bbox="381 934 893 1144" data-label="Image"> </div> <p>This device is treadmill with harness system can provide the patient with a safe supported partial weight bearing environment for gait therapy.</p> |
| <p>درج خشب corner stair</p> | <p>درج خشبي يتخدم لتدريب المريض على المشي والطلوع والنزول من الدرج ويستخدم في التاهيل</p> |
| <p>Therapy Mats 2 package of puzzle floor mat</p> | <p>The package contains 20 foam and colorful tiles ,colors Green, Red, Blue, Yellow ,Pink. Each tile in the package measure 12 inches by 12 inches</p> <div data-bbox="365 1449 633 1554" data-label="Image"> </div> |
| <p>Electrical Tilting Table</p> | <div data-bbox="365 1564 535 1732" data-label="Image"> </div> <p>A specially designed tilting table for moving patients steplessly from horizontal to vertical, between 0 and 90°. The ideal couch for neuromotor treatments, among others. Children can also be treated safely and without problems. The Tilt comes as a 1-section or as a 2-section couch. • Tilts from 0 to 90° • Suitable for children • Electrical height adjustment • Large wheels for safe movement</p> |





| ITEM | DESCRIPTION- الصورة للتوضيح |
|--------------------------------------------|-----------------------------------------------------------------------------------------------------------------------------------------------------------------------------------------------------------------------------------------------------------------------------------------------------------------------------------------------------------------------------------------------------------------------------------------------------------------------------------------------------------------------------------------------------------------------------------------------------------------------------------------------------------------------------------------------------------------------------------------------------------------------------------------------------------------------------------|
| Quadriceps Exerciser |  <p data-bbox="381 462 1258 535">multipurpose chair for muscle training and for upper- and lower limb rehabilitation</p> <ul data-bbox="430 567 1258 976" style="list-style-type: none"> • the swinging arm can be used on both sides • resistance is obtained by applying the weights: 4 x 2 kg, 1 x 1 kg, 1 x 0,5 kg • load, movement range and application point can all be independently adjusted • the backrest can be horizontally adjusted up to 90° by means of a gas spring • in order to allow leg exercise in prone position, the backrest can be pulled down upon 180° • thighs can be fixed by a upholstered support system and feet can be fastened by means of straps |
| Wall Pulley with Full Standard Accessories |  |
| Mobile Mirrors (4 castors) |  <p data-bbox="560 1543 941 1585">مراية عجلات متحركة اطارها خشبي</p> |
| Thera-Band |  <p data-bbox="609 1722 1201 1764">مطاط بالوان مختلفة ومقاومات مختلفة تستخدم في التمارين</p> |
| Wooden Wall Ladder | <p data-bbox="365 1764 1218 1837">سلم حائط مصنوع من الخشب الصلب باطوال مختلفة يستخدم للتمارين العلاجية للكبار والصغار</p>  |





| ITEM | DESCRIPTION- الصورة للتوضيح |
|-------------------------------------------|----------------------------------------------------------------------------------------------------------------------------------------------------------------------------------------------------------------------------------------------------------------------------------------------------------------------------------------------------------------------------------------------------------------------------------------------------------------------------------------------------------------------------------------------------------------------------------------------------------------------------------------------------------------------------------------------------------------------------------------------------------------------------------------------------------------------------------------------------------------------------------------------------------------------------------------------------------------------------------------------------------------------------------------------------------------------------------------------------------------------------------------------------------------------------------------------------------------------------------------------------------------------------------------------------------------------------------------------------------------------------------------------------------------------------------------------------------------|
| Standard Accessories for Suspension Frame | <div data-bbox="391 264 646 506" data-label="Image"> </div> <p data-bbox="646 478 1040 516">)Fixed point- suspension frame</p> <p data-bbox="391 558 646 596">2) Supporting ropes</p> <p data-bbox="391 632 548 737">Single rope Double rope Pulley rope</p> <p data-bbox="391 779 505 816">3) Sling</p> <p data-bbox="391 852 602 999">Single sling Double sling Three-ring sling Head sling</p> <p data-bbox="391 1035 610 1073">4) Wooden cleat</p> <p data-bbox="391 1108 651 1146">5) Dog clip, S hook</p> <p data-bbox="391 1182 667 1220">1) Suspension frame-</p> <p data-bbox="391 1255 1252 1360">It is made of stainless steel or plastic-coated steel. In the top and head-end side presents the 5-centimeter metal mesh, and the remaining sides are kept open.</p> <p data-bbox="391 1402 651 1440">2) Supporting rope-</p> <p data-bbox="391 1476 1235 1545">Three varieties of supporting ropes are used for the suspension to avoid slipping.</p> <p data-bbox="391 1581 553 1686">Single rope Double rope Pulley rope</p> <p data-bbox="391 1728 578 1766">a) Single rope</p> <p data-bbox="391 1801 1284 1948">It has a ring fixed at one end by which it is hung up. The other end of the rope then passes through one end of the wooden cleat through the ring of a dog clip and the other end of the cleat and then knotted.</p> <p data-bbox="391 1990 586 2028">b) Pulley rope</p> |

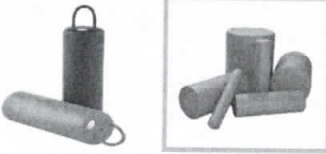





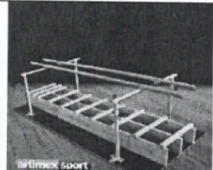

| ITEM | DESCRIPTION- الصورة للتوضيح |
|------|------------------------------------------------------------------------------------------------------------------------------------------------------------------------------------------------------------------------------------------------------------------------------------------------------------------------------------------------------------------------------------------------------------------------------------------------------------------------------------------------------------------------------------------------------------------------------------------------------------------------------------------------------------------------------------------------------------------------------------------------------------------------------------------------------------------------------------------------------------------------------------------------------------------------------------------------------------------------------------------------------------------------------------------------------------------------------------------------------------------------------------------------------------------------------------------------------------------------------------------------------------------------------|
| | <p>This has a dog clip attached at one end of the rope which then passes over the wheel of a pulley The rope then passes through the cleat and second dog clip.</p> <p>c) Double rope</p> <p>Consists of two pulleys at upper and lower attachments. So here there is a mechanical advantage of 2.</p> <p>3) Slings</p> <p>four varieties of slings are available-</p> <p>Single sling Double sling Three-ring sling Head sling</p> <p>a) Single sling</p> <p>Made of canvas bound with soft webbing and with a D ring at each end. Size- 68cm length and 17cm width. Used for elbow and knee Some time folded in the figure of 8 manner to support the wrist and ankle.</p> <p>b) Double sling</p> <p>Bigger than single sling It will have more than two sides with the D- rings. Used to support bigger parts like thorax, trunk, and thigh. Size- 68cm long and 29cm width.</p> <p>c) Three -ring sling</p> <p>75cm length, 3-4cm width, consist of 3 D rings. Two D rings at both the end of the sling and one in the middle kept moving. Used for wrist and ankle region.</p> <p>d) Head sling</p> <p>This is a short, split sling with its two halves stitched together at an angle to create a central slit.</p> |







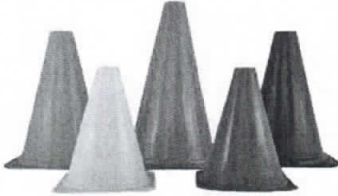

| ITEM | DESCRPTION- الصورة للتوضيح |
|--------------------------------------|-----------------------------------------------------------------------------------------------------------------------------------------------------------------------------------------------------------------------------------------------------------------------------------------------------------------------------------------------------------------------------------------------------------------------------------------------------------------------------------------------------------------------|
| | <p>It is used for head support in the middle of the sling present a slit for the accommodation of occipital region while in supine or lower ear accommodation while in side-lying.</p> <p>4) Wooden cleat</p> <p>Its made of wood and is used for altering the rope. It has two or three holes for the rope passage. The rope itself holds the cleat by friction resistance.</p> <p>5) Dog clip/ S hook</p> <p>Used to attach the supporting rope with mesh To attach the sling with supporting rope.</p> |
| Rollers (one set) |  <p>set of therapeutic rolls with different sizes.(the material is foam)</p> |
| Paraffin Wax |  <p>شمع بارافين يستخدم في جهاز البرافين قابل للذوبان</p> |
| Alcohol 70% | كحول طبي تركيز 70% |
| Weights Set | اوزان ثابتة رملية مجموعتهم اوزان مختلفة |
| Ultra Sound Gel | Medical gel special for ultrasound |
| درج سرير مرضى | درج احادي وثنائي يستخدم لصعود المريض على السرير ممكن ان يكون من الخشب او الحديد |
| مخدة اكريلان | مخدة طبية بمواصفات لتفادي الم الرقبة والعمود الفقري |
| Electronic Scale | ميزان بسيط لقياس الوزن فقط دون الطول |
| Therapeutic balls (different sizes) | <p>These innovative and adaptive exercise balls are ideal for immediate rehabilitation following an injury, as well as meditative daily stretching & muscle strengthening.</p> <p>Thera-Band Exercise Balls come with two plugs, an inflation adapter and a helpful poster illustrating 24 exercises. Three different sizes of balls are offered to accommodate user height variations.</p>  |

| ITEM | DESCRIPTION- الصورة للتوضيح |
|----------------------------------|----------------------------------------------------------------------------------------------------------------------------------------------------------------------------------------------------------------------------------------------------------------------------------------|
| Dumbble |  <p>مجموعة اوزان مختلفة م والوان مختلفة مع حامل اوزان</p> |
| جهاز الدراجة الهوائية الثابتة | دراجة هوائية ثابتة سهلة الاستخدام للكبار والاطفال تستخدم في التمارين العلاجية |
| Walkers for adult |  |
| Small pediatric standar |  <p>This item including small kids standing device with the height is adjustable and removable table</p> |
| Paraffin Oil (mineral oil) | زيت برفاين للمساج |
| Elbow craches for adult | أدوات مساعدة للتنقل /عكازات بحجم مناسب للكبار |
| Elbow craches for children | أدوات مساعدة للتنقل/ عكازات بحجم مناسب للأطفال |
| Wedges cushion |  <p>this item includes different sizes, The Wedge is soft touch, as it is made with foam and a very durable outer layer which prevent cracking, impermeable to fluids and easy to clean</p> |
| شراشف طبية | شراشف اسرة طبية لون ازرق غامق |
| بشاكير حجم وسط | بشاكير قطن حجم وسط لون واحد |
| بشاكير حجم كبير | بشاكير قطن حجم كبير منشفة لون واحد |
| Massage Tools (set) |  <p>أدوات خشب مختلفة الاشكال تستخدم في المساج والتدليك</p> |
| Walking ladder |  |



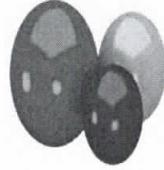

| ITEM | DESCRIPTION- الصورة للتوضيح |
|------------------------------|--------------------------------------------------------------------------------------------------------------------------------------------------------------------------------------------------------------------------------------------------------------------------------------------------------------------------------------------------------------------------------------------------------------|
| Wheel chair |  <ul style="list-style-type: none"> • Folding wheelchair with safety belt • Chrome plated steel frame with fixed arm & footrest • Superior quality wheels • Seat width: 46 cms(approx); Max load bearing: 100 kgs(approx) • Net Weight of wheelchair: 18 kgs(approx) |
| منشر غسيل |  |
| Trangular |  |
| تم توصيفه من | ===== |
| Disposable Covers | اغطية ملف رول الوان مختلفة توضع للمساج |
| Under Sheet 200*85 cm | اغطية مع رابط حول الاسرة لون ابيض |
| وجه مخدة | وجوه مخدات لون ازرق غامق |
| PT Assessment | مجموعة تحتوي على جميع الادوات المستخدمة في عملية التقييم للمريض من حالات العظام والاعصاب والاطفال |
| Rings |  <p>plastic and colorful plastic ring set</p> |
| Traffic cones |  <p>Plastic colorful Marker Cones(package include 6 pieces)</p> |
| Wooden ramp (crubs -ramp) |  <p>wood ramp with multiple height curbs</p> |



| ITEM | DESCRIPTION- الصورة للتوضيح |
|--------------------------------------|--------------------------------------------------------------------------------------------------------------------------------------------------------------------------------------------------------------------------------------------------------------------------------------------------------------------------------------------------------|
| Hand exercise web (resistance ring) |  <p>Different colours offer progressively more resistance for to a different resistance web (soft, med, heavy).</p> |
| Barrel roll (tumble form) |  <p>Allows gentle rocking and rolling experiences for balance training. Size: 56 x 51cm; Internal diameter 30.5cm</p> |
| Massage vibrator |  <p>Application Body Massager</p> |
| Half cylinder cushion |  |
| Balls |  <p>different size playing balls</p> |
| Airex non slip mat |  <p>Airex therapeutic mat for exercises: made of closed-cell foam which will not absorb fluids or moisture. They provide a safe and comfortable base and may be rolled up for storage or transportation. Measuring 2 metres by 1.25 metres and 15 mm depth.</p> |

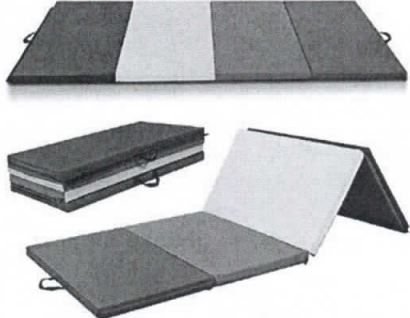

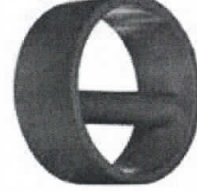
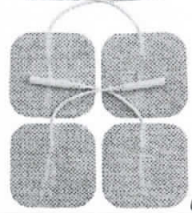
| ITEM | DESCRPTION- الصورة للتوضيح |
|----------------------------------------------|-------------------------------------------------------------------------------------------------------------------------------------------------------------------------------------------------------------------------------------------------------------------------------------------------------------------------------------------------------------------------------------------------------------|
| Fillable strength training balls with handel |  <p>Made from elastic material, which enables them to be filled with up to 3.5 kg of water or 5.5kg of sand. Can be used with hands or feet. Particularly suitable for muscular strength and stamina exercises and to strengthen wrists and ankles.</p> |
| Multicolor folding mat |  <p>foldable balancing and training colorful mat</p> |
| Mobility exercises arc |  <p>Single Curved Shoulder Arc</p> |
| Pronator - supinator tool for exercise |  <p>pronator- supinator wheel tool for upper limb and hand Pronation/Supination Wheel Hand Exerciser allows for pronation and supination exercises and features a nonslip rubber exterior for smooth, stable motions. The wheel allows for targeted training. A comfortable middle handle accommodates any hand size</p> |
| Pt-electrode |  <p>الكتروادات احجام مختلفة واشكال مختلفة مع لواصق</p> |

